

OBD Snoop ID88



A world-first
cloning solution

NETWORK WITH US



Silca key blanks are compatible with third party manufacturers' cylinders specified here below:











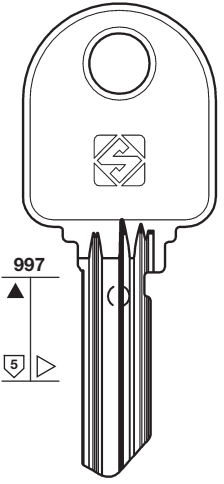

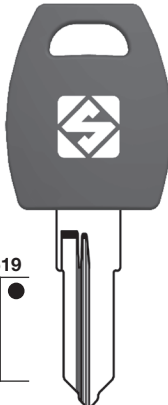

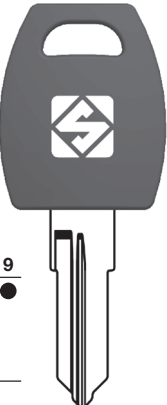

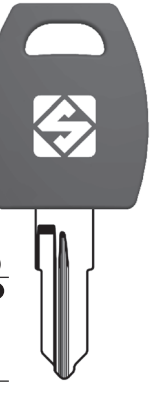
CORNI*		FICHET*	
<p>1467</p>		<p>P405</p>	
<p>6P7MP</p>		<p>FT530P</p>	
<p>8 052782 038230</p> <p>Box of 25</p>		<p>8 052782 036526</p> <p>Box of 25</p>	
LAPERCHE*			
<p>997</p>			
<p>LH44R</p>	<p>LH45R</p>	<p>LH46R</p>	<p>LH47R</p>
<p>8 052782 040660</p> <p>Box of 50</p>	<p>8 052782 040677</p> <p>Box of 50</p>	<p>8 052782 040684</p> <p>Box of 50</p>	<p>8 052782 040691</p> <p>Box of 50</p>

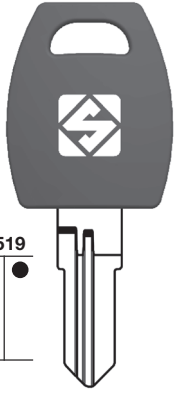
CORNI*^(IT)
FICHET*^(FR)

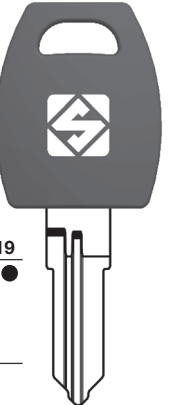
(*) This is a trademark of a third party not affiliated nor linked with Silca S.p.A. or the dormakaba Group. Silca S.p.A. and dormakaba Group do not own any intellectual property right nor have been granted any license with regard to such trademark, which is hereby used only to indicate the intended purpose of Silca's products.

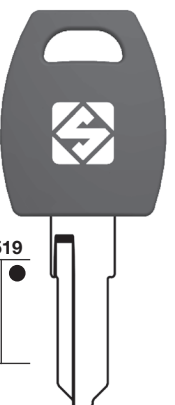

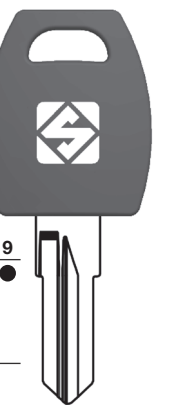







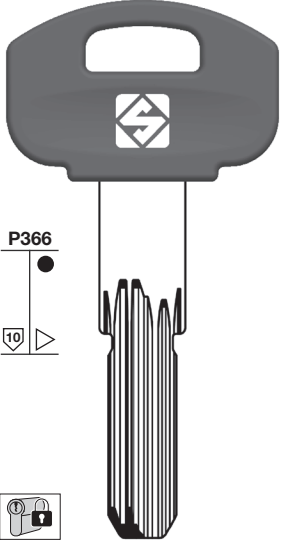



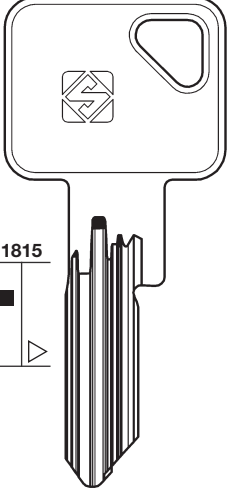

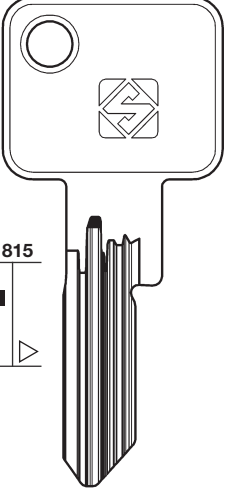

Silca key blanks are compatible with third party manufacturers' cylinders specified here below:

LAPERCHE*	MERONI*				
 <p>997 5</p> <p>LH48R</p>  <p>8 052782 040707 Box of 50</p>	<div style="display: flex; justify-content: space-around;"> <div data-bbox="454 414 662 817">  <p>P519</p> <p>MER34RP</p>  <p>8 052782 039008 Box of 25</p> </div> <div data-bbox="742 414 949 817">  <p>P519</p> <p>MER35RP</p>  <p>8 052782 038995 Box of 25</p> </div> <div data-bbox="1029 414 1236 817">  <p>P519</p> <p>MER43RP</p>  <p>8 052782 038988 Box of 25</p> </div> </div>				<p>LAPERCHE* (FR)</p> <p>MERONI* (IT)</p>
MERONI*					<p>(*) This is a trademark of a third party not affiliated nor linked with Silca S.p.A. or the dormakaba Group. Silca S.p.A. and dormakaba Group do not own any intellectual property right nor have been granted any license with regard to such trademark, which is hereby used only to indicate the intended purpose of Silca's products.</p>
<div style="display: flex; justify-content: space-around;"> <div data-bbox="119 1288 327 1691">  <p>P519</p> <p>MER44RP</p>  <p>8 052782 038971 Box of 25</p> </div> <div data-bbox="438 1288 646 1691">  <p>P519</p> <p>MER47RP</p>  <p>8 052782 038964 Box of 25</p> </div> <div data-bbox="726 1288 933 1691">  <p>P519</p> <p>MER48RP</p>  <p>8 052782 038957 Box of 25</p> </div> <div data-bbox="1013 1288 1220 1691">  <p>P519</p> <p>MER49RP</p>  <p>8 052782 038940 Box of 25</p> </div> </div>					

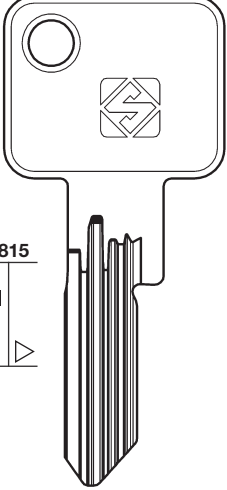

Silca key blanks are compatible with third party manufacturers' cylinders specified here below:

SECUREMME*	VACHETTE*			
 <p>P366</p>    <p>SCM5RP</p>  <p>8 052782 039015 Box of 25</p>	 <p>1815</p>   <p>VAC160</p>  <p>8 052782 039077 Box of 50</p>	 <p>1815</p>   <p>VAC161</p>  <p>8 052782 039084 Box of 50</p>	 <p>1815</p>   <p>VAC162</p>  <p>8 052782 039091 Box of 50</p>	<p>SECUREMME*^(IT)</p> <p>VACHETTE*^(FR)</p>
<p>(*) This is a trademark of a third party not affiliated nor linked with Silca S.p.A. or the dormakaba Group. Silca S.p.A. and dormakaba Group do not own any intellectual property right nor have been granted any license with regard to such trademark, which is hereby used only to indicate the intended purpose of Silca's products.</p>				

Silca Remote Car Key HU-AR22 compatible with Audi*

New Remote Key

Silca is pleased to introduce a new reference for duplicating Audi* A3 and Q2 remote car keys: the perfect solution for replacing damaged or lost original keys, or to have a duplicate in case of emergency. The Silca Remote Car Key HU-AR22 has a similar design to the original key and is supplied ready-to-programme with two flip blades HU66 and HU162 included.



HU-AR22

Flip blades HU162 & HU66

Nuova Chiave Radiocomando

Silca presenta una nuova referenza per la duplicazione di chiavi radiocomandi compatibile con la Audi* A3 e Q2: la soluzione perfetta per sostituire chiavi originali danneggiate o perse, o semplicemente per avere un duplicato da utilizzare in caso di emergenza.

Neuer Silca-Fernbedienungsschlüssel

Silca freut sich, eine neue Referenz für das Duplizieren von Autoschlüsseln mit Fernbedienung vorzustellen, die mit dem Audi* A3 und Q2 kompatibel sind: die perfekte Lösung, um beschädigte oder verloren gegangene Originalschlüssel zu ersetzen oder einfach, um einen Zweitschlüssel für den Notfall zu haben.

Nouvelle Clé Télécommande

Silca présente un nouvel article pour reproduire des clés télécommandes compatibles avec Audi*: la solution parfaite pour remplacer les clés abîmées ou perdues, ou tout simplement pour avoir un duplicata à utiliser en cas d'urgence.

Nova Chave Mando Silca

A Silca apresenta uma nova referência para a duplicação de chaves comando compatível com Audi*: a solução perfeita para substituir chaves originais danificadas ou perdidas, ou para ter um duplicado a utilizar em caso de emergência.

Nueva Llave Comando Silca

Silca presenta una nueva referencia para la duplicación de llaves con mando compatibles con Audi*: la solución perfecta para sustituir llaves estropeadas, extraviadas o simplemente para obtener un duplicado requerido por el cliente.



Application list for HU-AR22

Make*	Model	Chassis	From	To	Buttons	Trp ID	Frequency	Silca Profile
Audi*	A3	8V (GEN 3)	2012	2020	3	88	433 AM	HU66
Audi*	Q2	GA (GEN 1)	2017	2019	3	88	433 AM	HU162

> More info at mykeyspro.com

* This is a trademark of a third party not affiliated nor linked with Silca S.p.A. or the dormakaba Group. Silca S.p.A. and dormakaba Group do not own any intellectual property right nor have been granted any license with regard to such trademark, which is hereby used only to indicate the intended purpose of Silca's products.



UPDATE YOUR SMART PRO NOW!

Data update with new vehicle applications / Aggiornamento dati con nuove applicazioni veicolo / Datenaktualisierung mit neuen Fahrzeug-Anwendungen / Mise à jour des données avec des nouvelles applications de véhicules / Actualización de datos con nuevas aplicaciones de vehículos / Atualização de dados com novas aplicações de veículos

Silca Advanced Diagnostics software to program car keys compatible with third party makes and models specified below:

REGION	MAKE*	MODEL*	YEAR START	YEAR END	KEY TYPE	SW MODULE
Europe	Citroën*	Jumper	2002	2006	BLADE	ADS2121
Africa	Hino*	300	2010	2022	BLADE	ADS2125
Asia	Toyota*	RAV4	2019	2023	PROX	ADS2328
Asia	Citroën*	C3	2016	2023	PROX	ADS2188
Asia	Mazda*	CX-30	2019	2023	PROX	ADS2322
Asia	Mercedes*	E-Class	2010	2014	SLOT	ADS2298
Asia	Daihatsu*	Wake	2013	2018	PROX	ADS2284
Asia	Suzuki*	Solio	2015	2020	PROX	ADS2233
Australia	Kia*	Rio	2016	2020	PROX	ADS2196
Australia	Kia*	Rio	2020	2023	PROX	ADS2196
Australia	Toyota*	Hilux	2020	2023	BLADE	ADS2174
Australia	Renault*	Trafic	2014	2019	CARD	ADS2268
S. America	Dodge*	Attitude	2015	2023	PROX SLOT	ADS2281
USA	Nissan*	Micra	2017	2022	BLADE	ADS2297
USA	Nissan*	Versa	2018	2021	BLADE	ADS2297
USA	Hyundai*	Tucson	2022	2022	REMOTE	ADS2321
USA	Infinti*	M35h	2012	2012	PROX	ADS2159
USA	Chevrolet*	Trax	2021	2022	PROX	ADS2279
USA	RAM*	3500	2019	2019	FOBIK	ADS2272

(*) This is a trademark of a third party not affiliated nor linked with Silca S.p.A. or the dormakaba Group. Silca S.p.A. and dormakaba Group do not own any intellectual property right nor have been granted any license with regard to such trademark, which is hereby used only to indicate the intended purpose of Silca's products.

> More info at mykeyspro.com

Key Programming Software Update compatible with Ford* ADS2269 - Code D753712AD FIRST AFTERMARKET SOLUTION IN THE WORLD

Advanced Diagnostics is pleased to announce an update of the ADS2269 key programming software compatible with Ford* to include many new applications. The software is the first solution worldwide to program both bladed and proximity keys for Ford* even when the alarm is active and in a situation of lost keys.



Aggiornamento Software compatibile con Ford* PRIMA SOLUZIONE AFTERMARKET AL MONDO

Advanced Diagnostics ha sviluppato un aggiornamento per il software ADS2269 compatibile con Ford* ampliando la copertura a numerosi modelli nuovi. È la prima soluzione al mondo in grado di programmare chiavi con radiocomando flip e di prossimità anche in caso di allarme attivo e in situazioni di perdita totale delle chiavi.



Programmier-Software-Update kompatibel mit Ford* DIE WELTWEIT ERSTE AFTERMARKET-LÖSUNG

Advanced Diagnostics hat ein Update für die ADS2287 Software entwickelt. Die Anwendungsliste wurde um viele weitere Modelle erweitert, die seit der ursprünglichen Softwareversion hinzugefügt wurden. Die Software ist weltweit die einzige Lösung, mit der Metall und Keyless-Go-Schlüssel programmiert werden können, selbst wenn der Alarm aktiviert oder der Original Schlüssel nicht mehr vorhanden ist.



Mise à jour du logiciel de programmation des clés compatible avec Ford* PREMIÈRE SOLUTION AU MONDE POUR LE MARCHÉ DE L'APRÈS-VENTE

Advanced Diagnostics a le plaisir d'annoncer une mise à jour du logiciel de programmation de clés ADS2269 compatible avec Ford* pour inclure de nombreuses nouvelles applications. Le logiciel est la première solution au monde permettant de programmer des clés à lame et de proximité pour Ford*, même lorsque l'alarme est activée et en cas de perte de clés.

Atualização de Software de Programação compatível com Ford* A PRIMEIRA SOLUÇÃO AFTERMARKET NO MUNDO

A Advanced Diagnostics tem o prazer de anunciar o lançamento de uma atualização do software ADS2269 para incluir muitos mais veículos adicionados desde o lançamento do software original. É a primeira solução do mundo para programar chaves de metal e de proximidade, mesmo em caso de alarme ativo e em situações de perda total da chave.

Actualización del Software de Programación para Ford* LA PRIMERA SOLUCIÓN AFTERMARKET EN EL MUNDO

Advanced Diagnostics se complace en anunciarles un nueva actualización del software ADS2269 para la programación de llaves compatible con Ford*, en el que se incluyen nuevos modelos de vehículos. Este software es la primera solución de mercado global para programar tanto llaves de proximidad como sin proximidad incluso cuando la alarma esta activada o en caso de pérdida total de llaves.

What else is needed?
An internet connection is required.



Smart Pro



HU101AP05



HU101AR24



HU101R15



HU198P14



HU101R10

* This is a trademark of a third party not affiliated nor linked with Silca S.p.A. or the dormakaba Group. Silca S.p.A. and dormakaba Group do not own any intellectual property right nor have been granted any license with regard to such trademark, which is hereby used only to indicate the intended purpose of Silca's products.

Software Applications (added models)

Ford* 2023 Update - ADS2269

TABLE

 *							
Ford* Bronco Sport 2021 - 2023 proximity key	✓	✓	✓	✓	✗		
Ford* Edge 2015 - 2017 proximity key	✓	✓	✓	✓	✗		
Ford* Endura 2018 - 2023 proximity key	✓	✓	✓	✓	✗		
Ford* Everest 2015 - 2022 proximity key	✓	✓	✓	✓	✗		
Ford* Explorer 2020 - 2022 proximity key	✓	✓	✓	✓	✗		
Ford* F-150 2018 - 2020 proximity key	✓	✓	✓	✓	✗		
Ford* Galaxy 2015 - 2019 proximity key	✓	✓	✓	✓	✗	ID47	HU101AP05
Ford* Ka 2019 - 2020 bladed key	✓	✓	✓	✓	✗		
Ford* Kuga 2019 - 2023 proximity key	✓	✓	✓	✓	✗	ID47	HU198P15
Ford* Mondeo 2014 - 2023 proximity key	✓	✓	✓	✓	✗	ID47	HU101AP05
Ford* Mustang 2015 - 2023 proximity key	✓	✓	✓	✓	✗	ID47	HU101AP05
Ford* Puma 2019 - 2023 bladed key	✓	✓	✓	✓	✗	ID47	HU101R15
Ford* Puma 2019 - 2022 proximity key	✓	✓	✓	✓	✗		
Ford* Ranger 2016 - 2019 bladed key	✓	✓	✓	✓	✗	ID47	HU101R15
Ford* Ranger 2018 - 2022 proximity key	✓	✓	✓	✓	✗		
Ford* Tourneo Connect 2018 - 2019 bladed key	✓	✓	✓	✓	✗	ID6E-63	HU101AR24
Ford* Tourneo Connect 2020 - 2021 proximity key	✓	✓	✓	✓	✗		
Ford* Transit Courier 2021 - 2023 bladed key	✓	✓	✓	✓	✗	ID63/6F-63	HU101R10
Ford* Transit Custom 2012 - 2022 bladed key	✓	✓	✓	✓	✗	ID47	HU101R15

> More info at mykeyspro.com

* This is a trademark of a third party not affiliated nor linked with Silca S.p.A. or the dormakaba Group. Silca S.p.A. and dormakaba Group do not own any intellectual property right nor have been granted any license with regard to such trademark, which is hereby used only to indicate the intended purpose of Silca's products.



OBD Snoop ID88

A world-first cloning solution

Compatible with Volkswagen* Group MQB



A world-first cloning solution for clones bladed keys for a range of Volkswagen* Group MQB models.

La prima soluzione al mondo per la clonazione di chiavi per una gamma di modelli MQB del Gruppo Volkswagen* / Eine Weltneuheit zum Klonen von Schlüsseln für eine Reihe von MQB-Modellen der Volkswagen*-Gruppe / La première solution mondiale de clonage pour une gamme de modèles MQB du groupe Volkswagen* / La primera solución de clonación en el mundo para una gama de modelos de la plataforma MQB del Grupo Volkswagen* / Uma solução de clonagem pioneira no mundo para uma variedade de modelos MQB do Grupo Volkswagen*.

APPLICATIONS**			
MAKE*	MODEL	FROM	TO
AUDI*	A3	2012	2017
AUDI*	Q2	2017	2019
AUDI*	S3	2015	2017
SEAT*	ATECA	2016	2018
SEAT*	CUPRA	2016	2017
SEAT*	IBIZA	2015	2017
SEAT*	LEON	2012	2023
SEAT*	TOLEDO	2013	2023
SKODA*	FABIA	2014	2020
SKODA*	OCTAVIA	2014	2023
SKODA*	RAPID	2013	2023
SKODA*	SUPERB	2015	2023
VOLKSWAGEN*	CRAFTER	2018	2023
VOLKSWAGEN*	GOLF	2013	2018
VOLKSWAGEN*	POLO	2014	2017
VOLKSWAGEN*	TIGUAN	2015	2018
VOLKSWAGEN*	TOURAN	2016	2023

** Not all vehicle systems covered / Non tutti i sistemi dei veicoli sono coperti / Nicht alle Fahrzeugsysteme abgedeckt / Tous les systèmes du véhicule ne sont pas couverts / Cobertura parcial, los modelos con cuadro virtual no están soportados/ No todos los sistemas MQB de los vehículos están soportados.



FOR MORE INFORMATION VISIT:

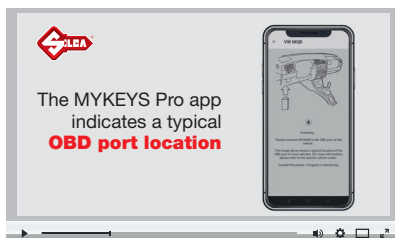

all Silca web sites
silca-automotive.com
advanced-diagnostics.com

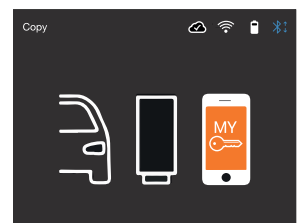

MYKEYS
Pro

(*) This is a trademark of a third party not affiliated nor linked with Silca S.p.A. or the dormakaba Group. Silca S.p.A. and dormakaba Group do not own any intellectual property right nor have been granted any license with regard to such trademark, which is hereby used only to indicate the intended purpose of Silca's products.



Futura Software Vers. 3.44.0 - DB 11.04 - Silca App. Vers. 2.9
Futura Pro Software Vers. 3.44.0 - DB 11.04 - Silca App. Vers. 2.9

NEW SYSTEMS

LOCK MANUFACTURER*	LOCK SYSTEMS*	PROFILE	SERIES	SN	DATA CARD	CLAMP
ABUS*	Abus* A91 (5P)	AO.....	00001-30000	10011	4684	01V
ALPHA*	Renault* Clio EMERGENZA	-	-	2418	5408	01R-01J-02J
BKS*	BKS* Series 57 (Prf. KA-KB-KC-KD)	-	-	2422	5413	01R-150-151
dormakaba* 	dormakaba* Ace (K72)	-	-	1307	3341	01R-01J-02J
FIAM*	-	123456	10019	5484	01V
GERDA*	Vita *	123456789	10018	5482	01V
HONDA*	AMAZE*	H...	H001-H999	2459	2354	01R-01J-02J 01R-106-107
LINCE*	Lince* 7x7x6 (XL)	-	-	2454	5466	01R-01J-02J
MCM*	MCM* BPS (6P)	0.....	162-17HH6	2447	3113	01R-01J-02J
METAL*	Metal* 2x6J	-	-	2457	5469	01R-01J-02J
METAL*	Metal* X6J	-	-	2456	5469	01R-01J-02J
MOIA*	MCHGYPC/C/30+10	-	-	2463	4172	01R-01J-02J
PRORACK*	-	...	001-100	10017	5473	01V
PRORACK*	HAVAL* (2T-8W)	-	-	2460	5483	01R-19J-02J 01R-106-107
SANDHAR*	TVS APACHE RTR 220			2445	5445	01R-19J-02J 01R-03J-02J
SILCA*	5EY35P (6+6+6)	-	-	10013	5454	01V+B14

(*) This is a trademark of a third party not affiliated nor linked with Silca S.p.A. or the dormakaba Group. Silca S.p.A. and dormakaba Group do not own any intellectual property right nor have been granted any license with regard to such trademark, which is hereby used only to indicate the intended purpose of Silca's products.

> More info on **all Silca websites** 



Futura Software Vers. 3.44.0 - DB 11.04 - Silca App. Vers. 2.9
Futura Pro Software Vers. 3.44.0 - DB 11.04 - Silca App. Vers. 2.9

NEW SYSTEMS

LOCK MANUFACTURER*	LOCK SYSTEMS*	PROFILE	SERIES	SN	DATA CARD	CLAMP
SILCA*	5EY35P (6+6+6)	-	-	10012	5453	01V+B14
SILCA*	DIR5R	-	-	2458	5481	01R-01J-02J
SUZUKI*	-	1234	10016	5471	01V
TriMark*	TriMark* (5P)	1001-1240	10014	5456	01V
YALE*	-	123	10015	5458	01V
YALE*	Yale* 2000 Plus Series	ABC10001-ADB18058	1660	4050	01R-19J-02J
ZEISS-IKON*	Zeiss-Ikon* Mirrored VRS	1234567890ABCDEFGHIL	10010	5452	01V+B18

(*) This is a trademark of a third party not affiliated nor linked with Silca S.p.A. or the dormakaba Group. Silca S.p.A. and dormakaba Group do not own any intellectual property right nor have been granted any license with regard to such trademark, which is hereby used only to indicate the intended purpose of Silca's products.

> More info on [all Silca websites](#)

Silca keys blanks are compatible with third-parties manufacturers cylinder specified here below:

FICHET* (F)

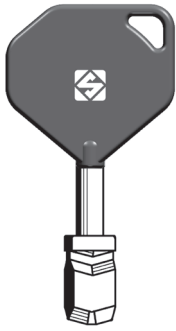

FT525P
(Fichet* 787)

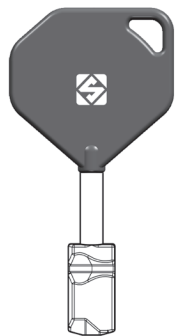

FT530P
(Fichet* 787Z)



MATRIX PRO - EVO
MATRIX PRO S - EVO S

OPTIONAL



D725483ZB

FICHET* Clamp
Morsetto FICHET*
FICHET* Spannbacke
Etau FICHET*
Mordaza FICHET*
Mordente FICHET*

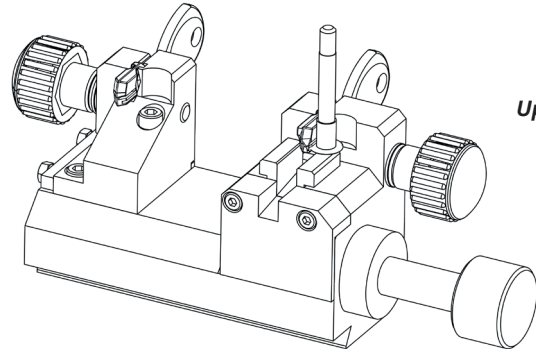

Update Clamp**

OPTIONAL

D740469ZB

Cutter F62W
Fresa F62W
Fräser F62W
Fraise F62W
Fresa F62W
Fresa F62W



D725731ZB

Tracer point T62
Tastatore T62
Taster T62
Palpeur T62
Tastatore T62
Palpador T62



**Design update to clamp both keys. Available on parts supplied after November 2023.

**Mise à jour de la conception pour serrer les deux clés. Disponible sur les pièces fournies après novembre 2023.

**Aggiornamento del design per bloccare entrambe le chiavi. Disponibile su opzionali forniti dopo novembre 2023.

**Actualización del diseño para sujetar ambas llaves. Disponible en piezas suministradas después de noviembre 2023.

**Design-Update, um beide Schlüssel zu klemmen. Verfügbar für Teile, die nach November 2023 geliefert werden.

**Atualização do design para fixar ambas as chaves. Disponível em peças fornecidas após novembro de 2023.

(*) This is a trademark of a third party not affiliated nor linked with Silca S.p.A. or the dormakaba Group. Silca S.p.A. and dormakaba Group do not own any intellectual property right nor have been granted any license with regard to such trademark, which is hereby used only to indicate the intended purpose of Silca's products.