

# SILCA NEWS

ALL THE NEW KEYS, AUTOMOTIVE SOLUTIONS, KEY CUTTING MACHINES, SOFTWARE UPDATES AND MUCH MORE

2023  
OCTOBER

NR.  
10



NETWORK WITH US





Silca key blanks are compatible with third party manufacturers' cylinders specified here below:

ESETY*		LOCKWOOD*		POTENT*		STUBLINA	
Box of 5		Box of 100		Box of 50		Box of 50	
STUBLINA		THIRARD*		UNIVERSAL*			
Box of 50		Box of 50		Box of 100		Box of 100	

**ESETY\*** (IT)

**LOCKWOOD\*** (AU)

**POTENT\*** (IT)

**STUBLINA\*** (RS)

**THIRARD\*** (FR)

**UNIVERSAL\***

(\*) This is a trademark of a third party not affiliated nor linked with Silca S.p.A. or the dormakaba Group. Silca S.p.A. and dormakaba Group do not own any intellectual property right nor have been granted any license with regard to such trademark, which is hereby used only to indicate the intended purpose of Silca's products.

## New Silca Remote Car Key OP-R39 compatible with Opel-Vauxhall\*



### **New Remote Key**

Silca is pleased to introduce a new reference for duplicating remote car keys compatible with Opel\*: the perfect solution for replacing damaged original remotes. The OP-R39 is designed to replace the remote part of the original key or to combine with the corresponding Silca horseshoe blade to make a complete new remote key.

### **Nuova Chiave Radiocomando**

Silca presenta una nuova referenza per la duplicazione di chiavi radiocomando compatibile con Opel\*: la soluzione perfetta per sostituire radiocomandi danneggiati.

### **Neuer Silca-Fernbedienungsschlüssel**

Silca freut sich, eine neue Referenz für die Duplizierung von Autoschlüsseln mit Fernbedienung, die mit Opel\* kompatibel sind, vorstellen zu können: die perfekte Lösung für den Ersatz von beschädigten Originalschlüsseln.

### **Nouvelle Clé Télécommande**

Silca présente un nouvel article pour reproduire des clés télécommande compatible avec Opel\*: la solution parfaite pour remplacer les clés originales abîmées.

### **Nueva Llave Comando Silca**

Silca presenta una nueva referencia para duplicar llaves con mando compatible con Opel\*: la solución perfecta para sustituir llaves originales estropeadas.

### **Nova Chave Mando Silca**

A Silca apresenta uma nova referência para a duplicação de chaves comando compatível com Opel\*: a solução perfeita para substituir chaves originais danificadas.



### Application list for OP-R39

Make*	Model	Chassis	From	To	Buttons	Trp ID	Frequency	Silca horseshoe blade
Opel-Vauxhall*	Corsa	A01 (XC)	2000	2004	2	ID40	433AM	HU46B
Opel-Vauxhall*	Corsa	A01 (XC)	2004	2006	2	ID40	433AM	HU100B
Opel-Vauxhall*	Combo	C	2001	2004	2	ID40	433AM	HU46B
Opel-Vauxhall*	Combo	C	2004	2011	2	ID40	433AM	HU100B
Opel-Vauxhall*	Meriva	X03 (XC)	2003	2004	2	ID40	433AM	HU46B
Opel-Vauxhall*	Meriva	X03 (XC)	2004	2010	2	ID40	433AM	HU100B
Opel-Vauxhall*	Tigra	(XC)	2004	2009	2	ID40	433AM	HU100B

> More info at [mykeyspro.com](https://mykeyspro.com)

\* This is a trademark of a third party not affiliated nor linked with Silca S.p.A. or the dormakaba Group. Silca S.p.A. and dormakaba Group do not own any intellectual property right nor have been granted any license with regard to such trademark, which is hereby used only to indicate the intended purpose of Silca's products.



UPDATE YOUR SMART PRO NOW!

FREE Update

Data update with new vehicle applications / Aggiornamento dati con nuove applicazioni veicolo / Datenaktualisierung mit neuen Fahrzeug-Anwendungen / Mise à jour des données avec des nouvelles applications de véhicules / Actualización de datos con nuevas aplicaciones de vehículos / Atualização de dados com novas aplicações de veículos

Silca Advanced Diagnostics software to program car keys compatible with third party makes and models specified below:

REGION	MAKE*	MODEL*	START YEAR	END YEAR	KEY TYPE	SW MODULE
Europe	Ford*	Transit Courier	2019	2023	BLADE	ADS2269
Europe	Opel*-Vauxhall*	Insignia	2017	2020	BLADE	ADS2279
Europe	Citroen*	Jumpy	2016	2023	PROX	ADS2188
Africa	Nissan*	Navara	2015	2023	PROX	ADS2159
Africa	Hyundai*	Elantra	2011	2015	BLADE	ADS2280
Asia	Suzuki*	Alto Lapin	2015	2020	PROX	ADS2233
Asia	Toyota*	Copen	2019	2023	PROX	ADS2284
Australia	Toyota*	Soarer	2001	2005	BLADE	ADS2125
Middle East	Toyota*	Corolla	2019	2023	PROX	ADS2296
New Zealand	Peugeot*	308	2013	2020	PROX	ADS2188
New Zealand	Alfa Romeo*	Mito	2008	2019	BLADE	ADS2258
New Zealand	Volkswagen*	Amarok	2017	2019	BLADE	ADS2292

(\*) This is a trademark of a third party not affiliated nor linked with Silca S.p.A. or the dormakaba Group. Silca S.p.A. and dormakaba Group do not own any intellectual property right nor have been granted any license with regard to such trademark, which is hereby used only to indicate the intended purpose of Silca's products.

> More info at [mykeyspro.com](https://mykeyspro.com)





## New Key Programming Software compatible with HYUNDAI KIA\* ADS2331 - Code D756916AD

Advanced Diagnostics is pleased to announce a new software release to read the security PIN code for most of the latest models from Hyundai\* and Kia\* including the popular Sportage\*, Soul\*, Kona\*, i10\*, i20\* and i30\*





 ADS2331 PIN Code Reading software reads the PIN code directly via the OBD socket for many previously unsupported models. For models where PIN code reading is not supported via OBD, the software can read the PIN code from a working key via the Smart Aerial+ (ADC245) when connected to Smart Pro.

 Il software ADS2331 legge il codice PIN direttamente tramite la presa OBD per molti modelli precedentemente non supportati. Per i modelli in cui la lettura del codice PIN non è supportata tramite OBD, il software può leggere il codice PIN da una chiave funzionante tramite Smart Aerial+ (ADC245) quando è connesso a Smart Pro.

 Die PIN-Code-Lesesoftware ADS2331 liest den PIN-Code direkt über die OBD-Buchse für viele bisher nicht unterstützte Modelle. Für Modelle, bei denen das Lesen des PIN-Codes über OBD nicht unterstützt wird, kann die Software den PIN-Code von einem funktionierenden Schlüssel über den Smart Aerial+ (ADC245) lesen, wenn eine Verbindung zur Smart Pro besteht.

 Le logiciel ADS2331 PIN Code Reading lit le code PIN directement via la prise OBD pour de nombreux modèles qui n'étaient pas pris en charge auparavant. Pour les modèles où la lecture du code PIN n'est pas prise en charge par l'OBD, le logiciel peut lire le code PIN à partir d'une clé fonctionnelle via la Smart Aerial+ (ADC245) lorsqu'elle est connectée à Smart Pro.

 O software de leitura de código PIN ADS2331 lê o código PIN diretamente através do soquete OBD para muitos modelos anteriormente não suportados. Para modelos onde a leitura do código PIN não é suportada via OBD, o software pode ler o código PIN de uma chave funcional através do Smart Aerial+ (ADC245) quando conectado ao Smart Pro.

 Este nuevo software ADS2331 lee el código PIN directamente a través del puerto OBD para muchos modelos que anteriormente no era compatible su lectura. Para los modelos donde la lectura del código PIN no es compatible a través del OBD, el software puede leer el código PIN desde una llave que arranque usando la Smart Aerial+ (ADC245) y la Smart Pro.



### What else is needed?

An internet connection is required.



Smart Pro



Smart Aerial+  
(for certain applications)

### OFFER DETAILS

Cable	ADC2000
Software category	A
Smart Aerial+	Yes (for certain applications)
Other software required	ADS2196 or ADS2321 (depending on the application)

> For full details of all 62 Hyundai\* and Kia\* model applications please check [mykeyspro.com](https://mykeyspro.com)



\* This is a trademark of a third party not affiliated nor linked with Silca S.p.A. or the dormakaba Group. Silca S.p.A. and dormakaba Group do not own any intellectual property right nor have been granted any license with regard to such trademark, which is hereby used only to indicate the intended purpose of Silca's products.



**SKP PRO 1/2023**  
for Web Subscribers

New cutting cards and series / Nuove schede e serie / Neue Karten und Serien / Nouvelles fiches et séries / Nuevas fichas y series / Novas fichas e séries

## SKP PRO 1/2023 - v. 31.4.4.x - Web Update

TRIAx PROGRAM		CODE PROGRAM	
Lock Manufacturer*	System*	Lock Manufacturer*	System*
BKS*	Bks* Series 57 (Prf. KA-KB-KC-KD)	ISEO*	Abus* A91 (5P)
ISEO* 	Iseo* CSF F90 SPI (9000D)	ISEO*	-
ISEO* 	Iseo* CSF F90 SPI (9000N)	ISEO*	-
LINCE*	Lince* 7x7x6 (W)	ISEO*	TriMark (5P)
LINCE*	Lince* 7x7x6 (XL)	ISEO*	-
MCM*	MCM* BPS (6P)	ISEO*	Zeiss-Ikon* Mirrored VRS
METAL*	Metal* 2x6J		
METAL*	Metal* x6J		
SANDHAR*	TVS* APACHE RTR 220		

(\*) This is a trademark of a third party not affiliated nor linked with Silca S.p.A. or the dormakaba Group. Silca S.p.A. and dormakaba Group do not own any intellectual property right nor have been granted any license with regard to such trademark, which is hereby used only to indicate the intended purpose of Silca's products.

> More info on [all Silca websites](#)

Silca keys blanks are compatible with third-parties manufacturers cylinder specified here below:

## BKS\* (DE)

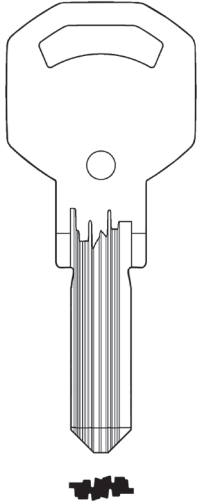

( Serie 57 System )  
Profiles KA-KB-KC-KD



**FUTURA PRO**  
**FUTURA**  
≥ SW 3.44.0

OPTIONAL



### D7A7416ZB

150 Jaw  
Ganascia 150  
150 Backe  
Mâchoire 150  
Quijada 150  
Garra 150

OPTIONAL



### D7A7417ZB

151 Jaw  
Ganascia 151  
151 Backe  
Mâchoire 151  
Quijada 151  
Garra 151

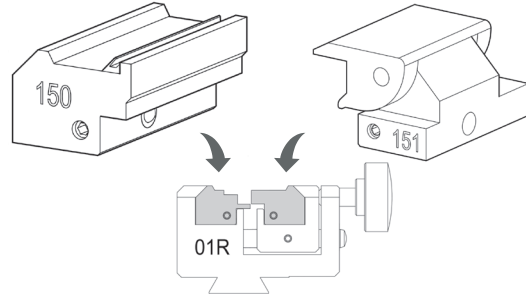

OPTIONAL



### D744514ZB

Cutter 08L  
Fresa 08L  
Fräser 08L  
Fraise 08L  
Fresa 08L  
Fresa 08L



**TRIAX PRO**  
≥ SW 3.0.036 DB 59.04

OPTIONAL



### D7A7416ZB

150 Jaw  
Ganascia 150  
150 Backe  
Mâchoire 150  
Quijada 150  
Garra 150

OPTIONAL



### D7A7417ZB

151 Jaw  
Ganascia 151  
151 Backe  
Mâchoire 151  
Quijada 151  
Garra 151

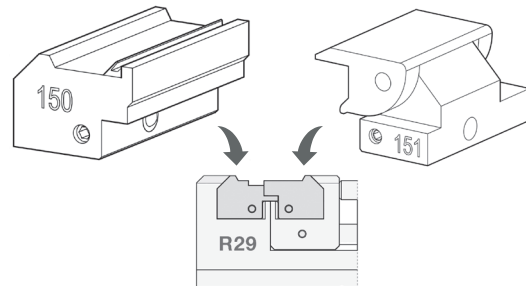

OPTIONAL



### D726008ZB

Cutter W273 (carbide)  
Fresa W273 (metallo duro)  
Fräser W273 (Hartmetall)  
Fraise W273 (au carbure)  
Fresa W273 (metal duro)  
Fresa W273 (metal duro)

(\*) This is a trademark of a third party not affiliated nor linked with Silca S.p.A. or the dormakaba Group. Silca S.p.A. and dormakaba Group do not own any intellectual property right nor have been granted any license with regard to such trademark, which is hereby used only to indicate the intended purpose of Silca's products.

Silca keys blanks are compatible with third-parties manufacturers cylinder specified here below:

## BKS\* (DE)

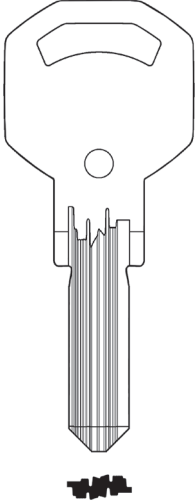

( Serie 57 System )  
Profiles KA-KB-KC-KD



**TRIAX QUATTRO**  
≥ SW 1.4.072 DB 59.04



**TRIAX-e.code**  
≥ SW 5.4.099 DB 59.04

### OPTIONAL D7A7416ZB



150 Jaw  
Ganascia 150  
150 Backe  
Mâchoire 150  
Quijada 150  
Garra 150

### OPTIONAL D7A7417ZB



151 Jaw  
Ganascia 151  
151 Backe  
Mâchoire 151  
Quijada 151  
Garra 151

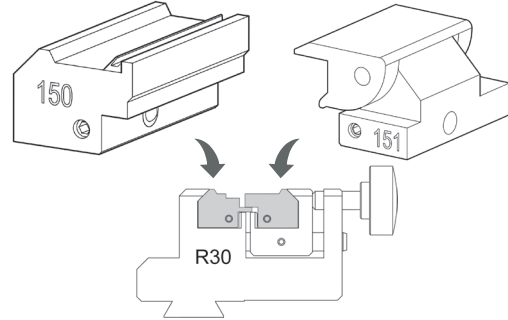

### OPTIONAL



### D726008ZB

Cutter W273 (carbide)  
Fresa W273 (metallo duro)  
Fräser W273 (Hartmetall)  
Fraise W273 (au carbure)  
Fresa W273 (metal duro)  
Fresa W273 (metal duro)

(\*) This is a trademark of a third party not affiliated nor linked with Silca S.p.A. or the dormakaba Group. Silca S.p.A. and dormakaba Group do not own any intellectual property right nor have been granted any license with regard to such trademark, which is hereby used only to indicate the intended purpose of Silca's products.



Silca keys blanks are compatible with third-parties manufacturers cylinder specified here below:

## ISEO\* (IT)

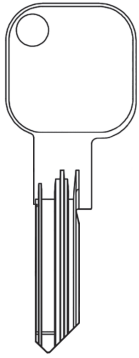

( CSF F90 SPI Systems )  
9000D - 9000N

Codes tables protected by a password issued by Silca on receipt of authorization.

Tabelle codici protette da password rilasciata da Silca a fronte di autorizzazione.

Code-Tabellen geschützt durch von Silca geliefertes Pas-sword auf Herstellersgenehmigung.

Tables de codes protégées par un password qui est émis par Silca sur autorisation.

Tablas codigos protegidos con contraseña que manda Silca previa autorización.

Tabelas de códigos protegidas por uma password emitida por Silca contra a autorização.

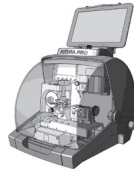

**FUTURA PRO**  
**FUTURA**  
≥ SW 3.43.0

**NEW**

OPTIONAL

**D7A7219ZB**

147 Jaw  
Ganascia 147  
147 Backe  
Mâchoire 147  
Quijada 147  
Garra 147



OPTIONAL

**D744634ZB**

51J Jaw  
Ganascia 51J  
51J Backe  
Mâchoire 51J  
Quijada 51J  
Garra 51J

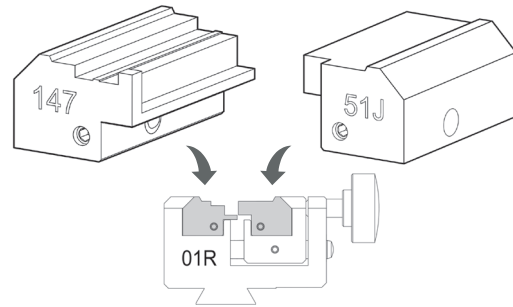

OPTIONAL



**D742867ZB**

Cutter 01D  
Fresa 01D  
Fräser 01D  
Fraise 01D  
Fresa 01D  
Fresa 01D



**TRIAX PRO**  
≥ SW 3.0.036 DB 59.04

**NEW**

OPTIONAL

**D7A7219ZB**

147 Jaw  
Ganascia 147  
147 Backe  
Mâchoire 147  
Quijada 147  
Garra 147



OPTIONAL

**D744634ZB**

51J Jaw  
Ganascia 51J  
51J Backe  
Mâchoire 51J  
Quijada 51J  
Garra 51J

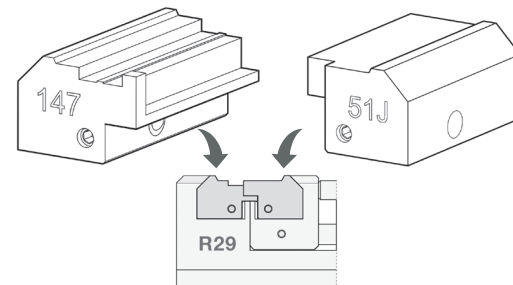

OPTIONAL

**D709117ZB**

Cutter H106 (HSS)  
Fresa H106 (HSS)  
Fräser H106 (HSS)  
Fraise H106 (HSS)  
Fresa H106 (HSS)  
Fresa H106 (HSS)



**D709243ZB**

Cutter W106 (carbide)  
Fresa W106 (metal duro)  
Fräser W106 (Hartmetall)  
Fraise W106 (au carbure)  
Fresa W106 (metal duro)  
Fresa W106 (metal duro)

(\*) This is a trademark of a third party not affiliated nor linked with Silca S.p.A. or the dormakaba Group. Silca S.p.A. and dormakaba Group do not own any intellectual property right nor have been granted any license with regard to such trademark, which is hereby used only to indicate the intended purpose of Silca's products.

Silca keys blanks are compatible with third-parties manufacturers cylinder specified here below:

## ISEO\* (IT)

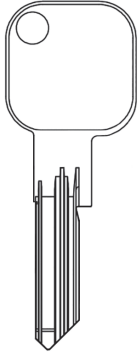

( CSF F90 SPI Systems )  
9000N - 9000D

Codes tables protected by a password issued by Silca on receipt of authorization.

Tabelle codici protette da password rilasciata da Silca a fronte di autorizzazione.

Code-Tabellen geschützt durch von Silca geliefertes Pas-sword auf Herstellersgenehmigung.

Tables de codes protégées par un password qui est émis par Silca sur autorisation.

Tablas códigos protegidos con contraseña que manda Silca previa autorización.

Tabelas de códigos protegidas por uma password emitida por Silca contra a autorização.



**TRIAX QUATTRO**  
≥ SW 1.4.072 DB 59.04



**TRIAX-e.code**  
≥ SW 5.4.099 DB 59.04



OPTIONAL



### D7A7219ZB

147 Jaw  
Ganascia 147  
147 Backe  
Mâchoire 147  
Quijada 147  
Garra 147

OPTIONAL



### D744634ZB

51J Jaw  
Ganascia 51J  
51J Backe  
Mâchoire 51J  
Quijada 51J  
Garra 51J

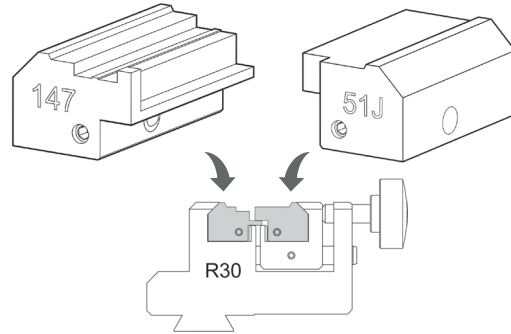

OPTIONAL

### D709117ZB

Cutter H106 (HSS)  
Fresa H106 (HSS)  
Fräser H106 (HSS)  
Fraise H106 (HSS)  
Fresa H106 (HSS)  
Fresa H106 (HSS)



### D709243ZB

Cutter W106 (carbide)  
Fresa W106 (metal duro)  
Fräser W106 (Hartmetall)  
Fraise W106 (au carbure)  
Fresa W106 (metal duro)  
Fresa W106 (metal duro)

## ZEISS-IKON\* (SE)

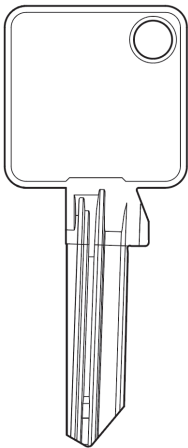

( VRS System )  
( Mirrored VRS System )



**FUTURA PRO  
FUTURA**  
≥ SW 3.44.0



**UNOCODE F100  
UNOCODE F400  
UNOCODE F600**



**UNOCODE F800  
UNOCODE F900**

OPTIONAL



## Mirrored VRS System



### D7A7332ZB

B18 adapter  
Adattatore B18  
Adapter B18  
Adaptateur B18  
Adaptador B18  
Adaptador B18

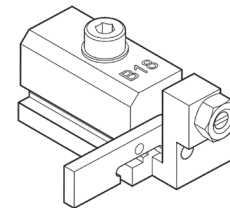

OPTIONAL



## VRS System

### D7A4369ZB

B17 adapter  
Adattatore B17  
Adapter B17  
Adaptateur B17  
Adaptador B17  
Adaptador B17

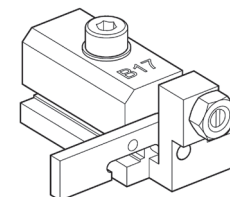

> More info at [mykeyspro.com](http://mykeyspro.com)



## IMPORTANT

In compliance with current regulations relating to industrial property, please note that - but for "Silca", "dormakaba", "Kaba", "Ilco" and "Advanced Diagnostics" - the trademarks or trade names mentioned in our document are the exclusive property of third parties not affiliated nor linked with Silca S.p.A. or the dormakaba Group. Silca S.p.A. and dormakaba Group do not own any intellectual property right nor have been granted any license with regard to such trademarks and trade names, which are hereby used only to indicate the intended purpose of Silca's products. / This catalogue is reserved exclusively for professional key cutters who use Silca products. The illustrations and technical data regarding the products in the document are to be considered indicative. Silca reserves the right to alter products designs, dimensions or info to improve the products quality. The contents of this document are fully protected by Copyright and may not be copied or reproduced in any form, without written permission from Silca S.p.A. Any controversy shall be settled by the Courts where the company Silca S.p.A. has its headquarters, with express exclusion of any other court.

## WICHTIG

In Übereinstimmung mit den geltenden Bestimmungen zum gewerblichen Eigentum weisen wir darauf hin, dass - mit Ausnahme von "Silca", "dormakaba", "Kaba", "Ilco" und "Advanced Diagnostics" - die in unserem Dokument erwähnten Markenzeichen oder Handelsnamen das ausschließliche Eigentum Dritter sind, die weder der Silca S.p.A. noch der dormakaba Gruppe angehören oder mit diesen verbunden sind. Diese Markenzeichen oder Handelsbezeichnungen werden hier nur erwähnt, um auf die bestimmungsgemäße Verwendung der Silca-Produkte hinzuweisen. / Dieser Katalog ist ausschließlich professionellen Schlüsseldiensten vorbehalten, die Silca-Produkte verwenden. Die in diesem Dokument enthaltenen Abbildungen und technischen Daten der Produkte sind als Richtwerte zu betrachten. Silca behält sich vor, etwaige Änderungen, die zur Verbesserung des Produktes beitragen, vorzunehmen. Alle Zeichnungen und Fotos sind Eigentum der Firma Silca. Jede Reproduktion, auch teilweise, ist ohne ausdrückliche Genehmigung der Silca S.p.A. gesetzlich untersagt. Im Falle von Streitfragen ist der Gerichtsstand des Firmensitzes Silca S.p.A. zuständig; jeder andere Gerichtsstand ist ausgeschlossen.

## IMPORTANTE

En cumplimiento de la normativa vigente en materia de propiedad industrial, se recuerda que, salvo para "Silca", "dormakaba", "Kaba", "Ilco" y "Advanced Diagnostics", las marcas y los nombres comerciales citados en nuestro documento son propiedad exclusiva de terceras sociedades, no afiliadas ni asociadas con Silca S.p.A. o el Grupo dormakaba. Dichas marcas o denominaciones comerciales se citan aquí solamente para indicar el empleo de destino de los productos Silca. / Este catálogo queda reservado exclusivamente a los duplicadores profesionales, que utilizan los productos Silca. Las ilustraciones y los datos técnicos de los productos contenidos en el documento se han de considerar indicativos. Silca se reserva el derecho, quedando invariables las características principales de los productos, de modificar todo lo que considere necesario y oportuno para mejorar la calidad de sus artículos. Todos los dibujos y fotografías pertenecen a Silca; según determina la Ley, se prohíbe toda reproducción, total o parcial, sin autorización por escrito de Silca S.p.A. En caso de disconformidad, la competencia es de las autoridades judiciales donde esté domiciliada la firma Silca S.p.A. excluyendo cualquier otro Tribunal.

## IMPORTANTE

In ottemperanza alla normativa vigente in materia di proprietà industriale, si ricorda che - fatta eccezione per "Silca", "dormakaba", "Kaba", "Ilco" e "Advanced Diagnostics" - i marchi o i nomi commerciali citati nel nostro documento sono di esclusiva proprietà di terzi, non affiliati né collegati a Silca S.p.A. o al Gruppo dormakaba. Silca S.p.A. e il Gruppo dormakaba non possiedono alcun diritto di proprietà intellettuale né agli stessi è stata concessa alcuna licenza in relazione a detti marchi o denominazioni commerciali, i quali sono qui citati solo per indicare la destinazione d'uso dei prodotti Silca. / Questo catalogo è riservato esclusivamente ai duplicatori professionisti che utilizzano i prodotti Silca. Le illustrazioni e i dati tecnici dei prodotti contenuti nel documento debbono considerarsi indicativi. Silca si riserva il diritto, ferme restando le caratteristiche essenziali dei prodotti, di apportare tutte le modifiche che ritiene necessarie e opportune al fine di migliorare la qualità dei prodotti. Tutti i disegni e le fotografie sono di proprietà di Silca, ogni riproduzione anche parziale, senza autorizzazione scritta di Silca S.p.A. è vietata secondo termini di legge. Per qualsiasi controversia competenti sono gli Uffici Giudiziari dove ha sede l'Azienda Silca S.p.A., con espressa esclusione di qualsiasi altro foro.

## IMPORTANT

Conformément à la législation en vigueur en matière de propriété industrielle, il est rappelé que - à l'exception de "Silca", "dormakaba", "Kaba", "Ilco" et "Advanced Diagnostics" - les marques ou noms commerciaux mentionnés dans notre document sont la propriété exclusive de tiers, non affiliés, ni liés à Silca S.p.A. ou au Groupe dormakaba. Ces marques ou dénominations commerciales ne sont mentionnées ici que pour indiquer la destination des produits Silca. / Ce catalogue est exclusivement réservé aux reproducteurs professionnels qui utilisent les produits Silca. Les illustrations et les données techniques des produits contenues dans le document doivent être considérées comme indicatives. Bien que les caractéristiques essentielles des produits soient invariables, Silca se réserve le droit d'apporter toutes les modifications qu'elle retiendra nécessaires et opportunes afin d'améliorer la qualité de ses produits. Tous les dessins et photos sont propriété Silca et toute reproduction, même partielle, sans l'autorisation écrite préalable de Silca S.p.A. est interdite conformément aux prescriptions légales. Tout litige est du ressort exclusif des Tribunaux de la circonscription où se trouve le Siège de la Société Silca S.p.A.

## IMPORTANTE

No respeito das normas em vigor relativas à propriedade industrial, lembra-se que - exceptuando "Silca", "dormakaba", "Kaba", "Ilco" e "Advanced Diagnostics" - as marcas ou os nomes comerciais citados no nosso documento são propriedade exclusiva de terceiros, não associados nem ligados à Silca S.p.A. ou ao Grupo dormakaba. Essas marcas ou denominações comerciais são citadas aqui somente para indicar o uso pretendido dos produtos Silca. / Este catálogo é reservado exclusivamente aos profissionais da duplicação que utilizam os produtos Silca. As figuras e as características técnicas dos produtos contidas no documento são facultadas a título indicativo. Mesmo que as características essenciais dos produtos sejam invariáveis, à Silca reserva-se o direito de modificar ser necessário e oportuno los produtos, afim de melhorar a sua qualidade. Todos os desenhos e fotos são propriedade da Silca, e é proibida a sua reprodução mesmo parcial sem a autorização escrita da Silca S.p.A. conforme as prescrições legais. Em caso de litígio fica desde já designado, excluindo qualquer outro, o Tribunal da comarca onde está registrada a sede da Silca S.p.A.