

SILCA NEWS

ALL THE NEW KEYS, AUTOMOTIVE SOLUTIONS, KEY CUTTING MACHINES, SOFTWARE UPDATES AND MUCH MORE

2023
SEPTEMBER











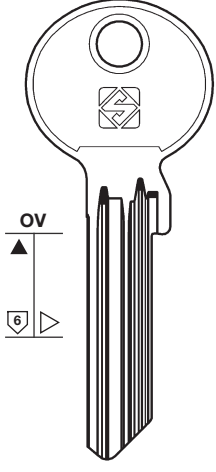
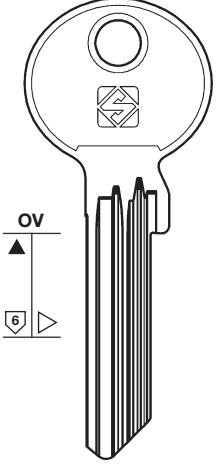
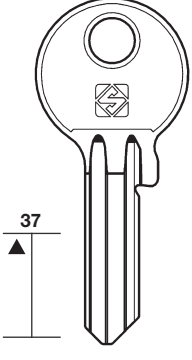



NR.
09

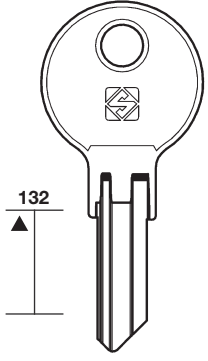
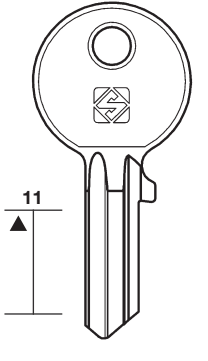
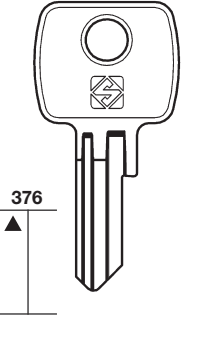
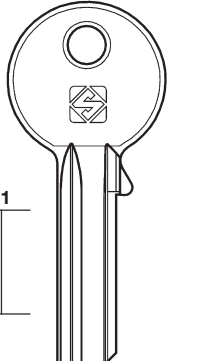

NETWORK WITH US



Silca key blanks are compatible with third party manufacturers' cylinders specified here below:

| ABUS* | | | |
|--|--|---|--|
|  <p>OV ▲ 6</p> |  <p>OV ▲ 6</p> |  <p>37</p> | ABUS* (DE) <hr/> BURG* (DE) |
|  <p>AB127R-2</p> |  <p>AB127R-3</p> |  <p>AB126</p> | |
|  <p>8 052782 036397</p> <p>Box of 50</p> |  <p>8 052782 036403</p> <p>Box of 50</p> |  <p>8 052782 036991</p> <p>Box of 100</p> | |
| BURG* | | | |
|  <p>132</p> |  <p>11</p> |  <p>376</p> |  <p>11</p> |
|  <p>BUR70</p> |  <p>BUR71</p> |  <p>BUR72</p> |  <p>BUR73</p> |
|  <p>8 052782 036335</p> <p>Box of 100</p> |  <p>8 052782 036328</p> <p>Box of 100</p> |  <p>8 052782 038339</p> <p>Box of 100</p> |  <p>8 052782 036366</p> <p>Box of 100</p> |

(*) This is a trademark of a third party not affiliated nor linked with Silca S.p.A. or the dormakaba Group. Silca S.p.A. and dormakaba Group do not own any intellectual property right nor have been granted any license with regard to such trademark, which is hereby used only to indicate the intended purpose of Silca's products.

Silca key blanks are compatible with third party manufacturers' cylinders specified here below:

| GEGE* | | GTV* | |
|---|--|---------------------------------------|--|
| <p>GE178RX-18</p> <p>Box of 50</p> | <p>GE178RX-19</p> <p>Box of 50</p> | <p>GV22</p> <p>Box of 100</p> | <p>GEGE* (AT)</p> <hr/> <p>GTV* (DE)</p> <hr/> <p>JUNIE* (DE)</p> <hr/> <p>MUL.T.LOCK* (IL)</p> <hr/> <p>NETHERLAND* (NL)</p> |
| JUNIE* | MUL.T.LOCK* | NETHERLAND* | |
| <p>JU18</p> <p>Box of 100</p> | <p>MTK24P</p> <p>Orig. code: 115</p> <p>Box of 25</p> | <p>6NTH-1</p> <p>Box of 25</p> | |

(*) This is a trademark of a third party not affiliated nor linked with Silca S.p.A. or the dormakaba Group. Silca S.p.A. and dormakaba Group do not own any intellectual property right nor have been granted any license with regard to such trademark, which is hereby used only to indicate the intended purpose of Silca's products.

Silca key blanks are compatible with third party manufacturers' cylinders specified here below:

NETHERLAND*

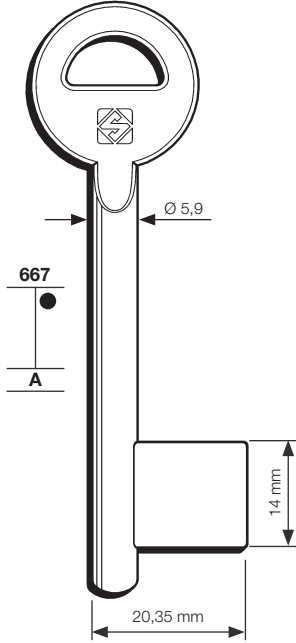

6NTH-2



8 052782 034560

Box of 25

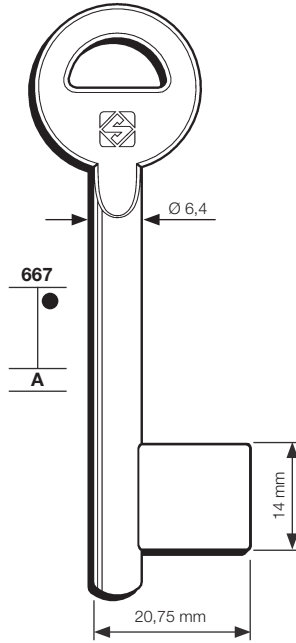

6NTH-3



8 052782 034577

Box of 25

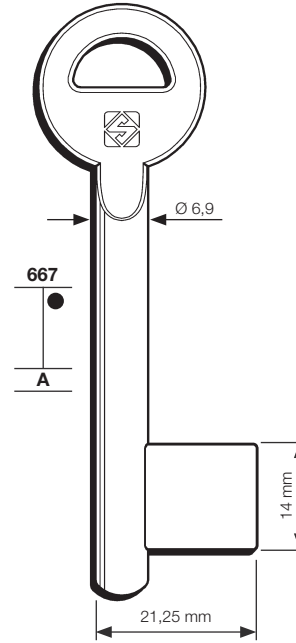

6NTH-4



8 052782 034584

Box of 25

NETHERLAND* (NL)

PFAFFENHAIN* (DE)

PREFER* (IT)

RONIS* (FR)

PFAFFENHAIN*

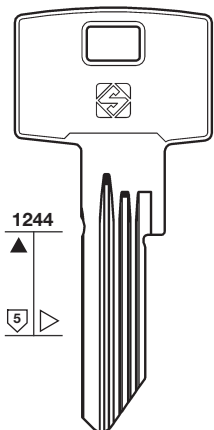

PHF51R



8 052782 036984

Box of 50

PREFER*

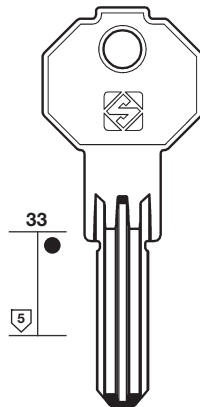

PF23



8 052782 035536

Box of 50

RONIS*

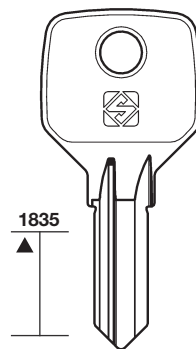

RO87



8 052782 037097

Box of 100

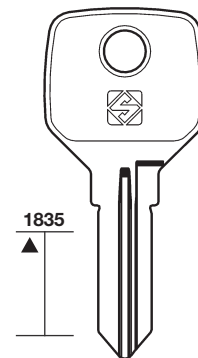

RO88



8 052782 034775

Box of 100







(*) This is a trademark of a third party not affiliated nor linked with Silca S.p.A. or the dormakaba Group. Silca S.p.A. and dormakaba Group do not own any intellectual property right nor have been granted any license with regard to such trademark, which is hereby used only to indicate the intended purpose of Silca's products.

Silca key blanks are compatible with third party manufacturers' cylinders specified here below:

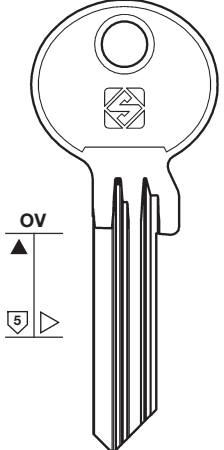
| TILANCO* | | |
|---|--|---|
| <p>P518</p> <p>TLC1RP</p> <p>8 052782 035857</p> <p>Box of 25</p> | <p>P518</p> <p>TLC2RP</p> <p>8 052782 035864</p> <p>Box of 25</p> | <p>P518</p> <p>TLC4RP</p> <p>HERACLES - YARDENI</p> <p>8 052782 035871</p> <p>Box of 25</p> |
| <p>TILANCO* (IT)</p> <p>TITAN* (SI)</p> <p>UNION* (GB)</p> <p>WANGTONG* (CN)</p> | | |
| TITAN* | UNION* | WANGTONG* |
| <p>1666</p> <p>Orig. code: Y8</p> <p>TN57</p> <p>8 052782 035222</p> <p>Box of 50</p> | <p>A</p> <p>6</p> <p>Orig. code: 112A</p> <p>Shoulder milling view</p> <p>UNI69SM</p> <p>8 052782 035888</p> <p>Box of 100</p> | <p>132</p> <p>WAN1</p> <p>8 052782 036410</p> <p>Box of 100</p> |

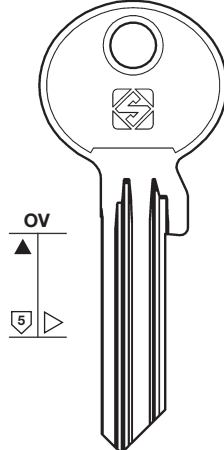
(*) This is a trademark of a third party not affiliated nor linked with Silca S.p.A. or the dormakaba Group. Silca S.p.A. and dormakaba Group do not own any intellectual property right nor have been granted any license with regard to such trademark, which is hereby used only to indicate the intended purpose of Silca's products.

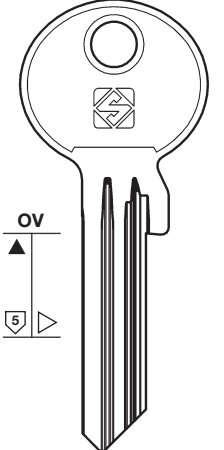
Silca key blanks are compatible with third party manufacturers' cylinders specified here below:

| WILKA* | | | WILKA* (DE) |
|---|---|---|--|
|  <p>OV ▲ 5 ▷</p>  <p>WK103RX-1</p>  <p>8 052782 037004 Box of 100</p> |  <p>OV ▲ 5 ▷</p>  <p>WK103RX-2</p>  <p>8 052782 037011 Box of 100</p> |  <p>OV ▲ 5 ▷</p>  <p>WK103RX-3</p>  <p>8 052782 037028 Box of 100</p> | <p>(*) This is a trademark of a third party not affiliated nor linked with Silca S.p.A. or the dormakaba Group. Silca S.p.A. and dormakaba Group do not own any intellectual property right nor have been granted any license with regard to such trademark, which is hereby used only to indicate the intended purpose of Silca's products.</p> |

New Silca Remote Car Key HU101BR38 compatible with the Ford* Transit



New Remote Key

Silca is pleased to introduce a new remote key compatible with the Ford* Transit. The key features three function buttons (lock, unlock and rear door open) and can be programmed with Smart Pro.

Nuova Chiave Radiocomando

Silca presenta una nuova referenza per la duplicazione di chiavi radiocomando compatibile con Ford* Transit. La chiave è dotata di tre pulsanti per l'apertura e chiusura centralizzata delle portiere e per l'apertura della porta posteriore. La chiave può essere programmata con Smart Pro.

Neuer Silca-Fernbedienungsschlüssel

Silca präsentiert eine neue Referenz für das Kopieren von Fernbedienungsschlüsseln kompatibel mit dem Ford* Transit. Der Schlüssel hat drei Tasten für die Zentralöffnung/-verriegelung der Türen und für die dritte Tür. Der Schlüssel kann mit Smart Pro programmiert werden.

Nouvelle Clé Télécommande

Silca présente un nouvel article pour reproduire des clés a télécommande pour le Ford Transit*. La clé a trois boutons pour le déverrouillage/verrouillage centralisé des portières et pour l'ouverture de la porte latérale. La clé peut être programmée sur Smart Pro.

Nova Chave Mando Silca

Silca apresenta uma nova referência para a duplicação de chaves comando compatível com a Ford* Transit. A chave tem três botões para a abertura e o fecho centralizado das portas e para a abertura da terceira porta. A chave pode ser programada com o Smart Pro.

Nueva Llave Comando Silca

Silca presenta una nueva referencia para duplicar llaves mando compatible con la Ford* Transit. La llave tiene tres botones para la apertura y el cierre centralizados de las puertas y para la apertura de la tercera puerta. La llave se puede programar con Smart Pro.



Application list for HU101BR38

| Make* | Model | Chassis | From | To | Buttons | Trp ID | Frequency | Silca Profile |
|-------|----------------|----------|------|------|---------|--------|-----------|---------------|
| Ford* | Torneo Custom | V362/363 | 2012 | 2016 | 3 | 6E-63 | 433FM | HU101 |
| Ford* | Transit | | 2013 | 2016 | 3 | 6E-63 | 433FM | HU101 |
| Ford* | Transit Custom | V362/363 | 2012 | 2016 | 3 | 6E-63 | 433FM | HU101 |

> More info at mykeyspro.com

* This is a trademark of a third party not affiliated nor linked with Silca S.p.A. or the dormakaba Group. Silca S.p.A. and dormakaba Group do not own any intellectual property right nor have been granted any license with regard to such trademark, which is hereby used only to indicate the intended purpose of Silca's products.

New key programming solution compatible with the Fiat* Panda model 169 Software ADS2185 + Remote Key SIP22R33

The unique solution for programming Fiat* Panda remotes entirely via OBD





 Produced in conformity with the CE mark European standards.



 The ADS2185 software programs remote keys for the 2003 to 2011 Fiat* Panda even in an all keys lost situation. The precoding for both the transponder and remote is read by the software and then written to the SIP22R33 key **only via the Smart Aerial+**.

 **La soluzione esclusiva** per la programmazione di chiavi con radiocomando Fiat* Panda modello 169 completamente via OBD senza effettuare operazioni invasive.

 **Die einzigartige Lösung** für die Programmierung von Fiat* Panda Modell 169 Fernbedienungen vollständig über OBD.

 **La solution unique** pour programmer les télécommandes Fiat* Panda modèle 169 entièrement via OBD.

 **A solução única** para programar os comandos do Fiat* Panda modelo 169 inteiramente via OBD.

 **La única solución** para la programación de mandos Fiat* Panda modelo 169 totalmente a través de OBD.

What else is needed?



Smart Pro



Smart Aerial+

ADS2185 Software details

| | |
|----------------------------|---------|
| Cable | ADC2000 |
| Software category | A |
| Smart Aerial+ | Yes |
| Other accessories required | No |

SIP22R34 Key details

| | |
|---------------|-------|
| Buttons | 3 |
| TRP ID | 46 |
| Frequency | 433AM |
| Silca Profile | SIP22 |

Applications

| | | | | | | | | |
|---|---|---|---|--|---|---|---|---|
|  * |  |  |  |  |  |  |  |  |
| Fiat* Panda (model code 169) 2003 -> 2011 |  |  |  |  | ADC2000 |  | ID46 | SIP22R33 |

> More info at mykeyspro.com

* This is a trademark of a third party not affiliated nor linked with Silca S.p.A. or the dormakaba Group. Silca S.p.A. and dormakaba Group do not own any intellectual property right nor have been granted any license with regard to such trademark, which is hereby used only to indicate the intended purpose of Silca's products.

New key programming software compatible with Volvo* ADS2334 - Code D756919AD

The **FIRST TO MARKET** solution for programming Volvo* proximity keys via OBD



 The software programmes slot and proximity keys for a selection of popular Volvo* models like the V60 and XC60. Used together with the new ADA2100 dongle, security data can be read from the vehicle ECU freeing up Smart Pro for other jobs.

 La PRIMA SOLUZIONE SUL MERCATO per la programmazione delle chiavi di prossimità Volvo* via OBD.

 Die ERSTE AUF DEM MARKT befindliche Lösung zur Programmierung von Volvo* Keyless-Go-Schlüsseln über OBD.

 La PREMIÈRE SOLUTION SUR LE MARCHÉ pour la programmation des clés de proximité Volvo* via OBD.

 A PRIMEIRA SOLUÇÃO DO MERCADO para a programação de chaves de proximidade Volvo* via OBD.

 La PRIMERA SOLUCIÓN DEL MERCADO para programar llaves de proximidad Volvo* a través del OBD.



What else is needed?



Silca Slot Key
HU152S16



Smart Pro



ADA2100 Volvo Dongle

OFFER DETAILS









| | |
|----------------------------|----------------------|
| Cable | ADC2000 |
| Software category | A |
| Smart Aerial required | No |
| Other accessories required | ADA2100 Volvo Dongle |

> More info at mykeyspro.com

* This is a trademark of a third party not affiliated nor linked with Silca S.p.A. or the dormakaba Group. Silca S.p.A. and dormakaba Group do not own any intellectual property right nor have been granted any license with regard to such trademark, which is hereby used only to indicate the intended purpose of Silca's products.

Applications

Smart Pro Volvo* Dongle ADA2100 & Key Programming Software ADS2334

|  * | KEY TYPE |  |  |  |  |  |  |  |
|---|-----------|---|---|---|---|---|---|---|
| Volvo* S60 2010 --> 2017 | Slot | ✓ | ✓ | ✓ | ✓ | ✗ | ID46 | HU152S16 |
| Volvo* S60 Cross Country 2010 --> 2017 | Slot | ✓ | ✓ | ✓ | ✓ | ✗ | ID46 | HU152S16 |
| Volvo* S80 2007 --> 2016 | Slot | ✓ | ✓ | ✓ | ✓ | ✗ | ID46 | HU152S16 |
| Volvo* V60 2011 --> 2018 | Slot | ✓ | ✓ | ✓ | ✓ | ✗ | ID46 | HU152S16 |
| Volvo* V60 Cross Country 2011 --> 2017 | Slot | ✓ | ✓ | ✓ | ✓ | ✗ | ID46 | HU152S16 |
| Volvo* V70 2008 --> 2016 | Slot | ✓ | ✓ | ✓ | ✓ | ✗ | ID46 | HU152S16 |
| Volvo* XC60 2009 --> 2017 | Slot | ✓ | ✓ | ✓ | ✓ | ✗ | ID46 | HU152S16 |
| Volvo* XC70 2007 -->2016 | Slot | ✓ | ✓ | ✓ | ✓ | ✗ | ID46 | HU152S16 |
| Volvo* S60 2010 --> 2017 | Prox-slot | ✓ | ✓ | ✓ | ✓ | ✗ | ID46 | HU152S16** |
| Volvo* S60 Cross Country 2010 --> 2017 | Prox-slot | ✓ | ✓ | ✓ | ✓ | ✗ | ID46 | HU152S16** |
| Volvo* S80 2007 --> 2016 | Prox-slot | ✓ | ✓ | ✓ | ✓ | ✗ | ID46 | HU152S16** |
| Volvo* V60 2011 --> 2018 | Prox-slot | ✓ | ✓ | ✓ | ✓ | ✗ | ID46 | HU152S16** |
| Volvo* V60 Cross Country 2011 --> 2017 | Prox-slot | ✓ | ✓ | ✓ | ✓ | ✗ | ID46 | HU152S16** |
| Volvo* V70 2008 --> 2016 | Prox-slot | ✓ | ✓ | ✓ | ✓ | ✗ | ID46 | HU152S16** |
| Volvo* XC60 2009 --> 2017 | Prox-slot | ✓ | ✓ | ✓ | ✓ | ✗ | ID46 | HU152S16** |
| Volvo* XC70 2007 --> 2016 | Prox-slot | ✓ | ✓ | ✓ | ✓ | ✗ | ID46 | HU152S16** |

**Slot key function only



> More info at mykeyspro.com

* This is a trademark of a third party not affiliated nor linked with Silca S.p.A. or the dormakaba Group. Silca S.p.A. and dormakaba Group do not own any intellectual property right nor have been granted any license with regard to such trademark, which is hereby used only to indicate the intended purpose of Silca's products.

Smart Pro Volvo* Dongle ADA2100 - Code D856910AD

The timesaving solution for programming Volvo* slot and proximity keys



The dongle connects directly to the vehicle OBD socket to read the security data from the vehicle ECU, freeing up Smart Pro for other jobs.

La soluzione che consente di risparmiare tempo per la programmazione delle chiavi Volvo* slot e di prossimità. Il dongle si collega direttamente alla presa OBD del veicolo per leggere i dati di sicurezza dall'ECU, liberando Smart Pro per effettuare altre attività.

Die zeitsparende Lösung für die Programmierung von Volvo* Slot- und Keyless-Go-Schlüsseln. Der Dongle wird direkt an die OBD-Buchse des Fahrzeugs angeschlossen, um die Sicherheitsdaten aus dem Steuergerät des Fahrzeugs auszulesen, wodurch die Smart Pro für andere Aufgaben frei wird.

La solution pour gagner du temps dans la programmation des clés de proximité et des clés à slot Volvo*. Le dongle se connecte directement à la prise OBD du véhicule pour lire les données de sécurité de l'ECU du véhicule, libérant ainsi Smart Pro pour d'autres tâches.

A solução para poupar tempo na programação de chaves de slot e de proximidade Volvo*. O dongle liga-se diretamente à tomada OBD do veículo para ler os dados de segurança da ECU do veículo, libertando o Smart Pro para outras tarefas.

La solución más rápida para programar llaves de proximidad y slot para Volvo. El dongle se conecta directamente al puerto OBD del vehículo para leer los datos de seguridad desde la ECU, dejando libre a la Smart Pro para su uso.

What else is needed?



Smart Pro



ADS2334
Key programming software



> More info at mykeyspro.com

* This is a trademark of a third party not affiliated nor linked with Silca S.p.A. or the dormakaba Group. Silca S.p.A. and dormakaba Group do not own any intellectual property right nor have been granted any license with regard to such trademark, which is hereby used only to indicate the intended purpose of Silca's products.

Silca GTI Ultra Transponder



✓ **ID48 Cloning**

Plus Renault Dacia ID49-1E* and Hyundai ID6K* and ID7K*

✓ **98% Coverage**

Compatible with 98% of clonable car keys

✓ **Lasts Longer**

The Silca GTI Ultra transponder is tested to hold cloned data for 35 years

✓ **10 year Guarantee**

Only Silca GTI Ultra transponders come with a 10 year guarantee

✓ **Wide Technology Coverage**

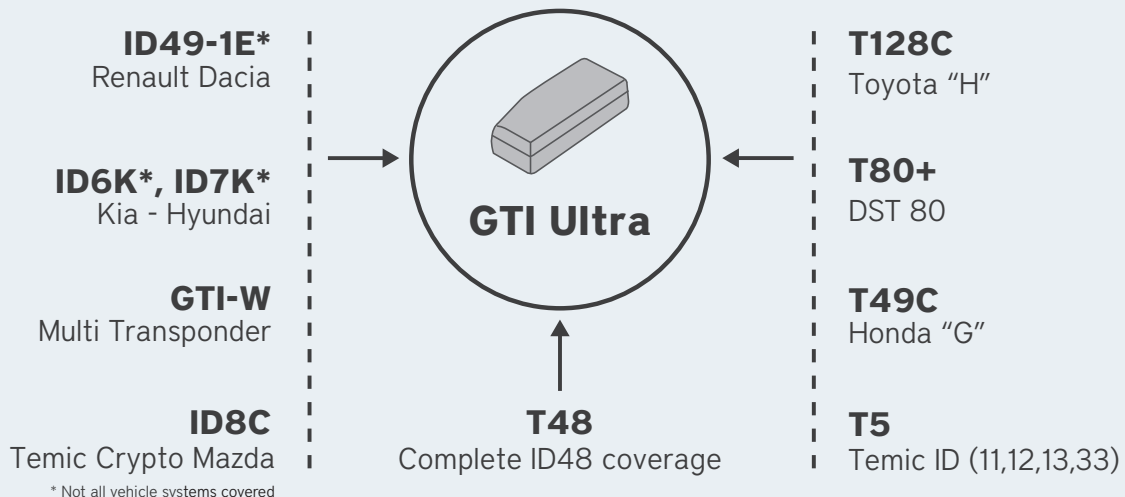

> More info at www.silca.biz - www.silca-automotive.com - www.mykeyspro.com



Data update with new vehicle applications / Aggiornamento dati con nuove applicazioni veicolo / Datenaktualisierung mit neuen Fahrzeug-Anwendungen / Mise à jour des données avec des nouvelles applications de véhicules / Actualización de datos con nuevas aplicaciones de vehículos / Atualização de dados com novas aplicações de veículos

Silca Advanced Diagnostics software to program car keys compatible with third party makes and models specified below:

| REGION | MAKE* | MODEL* | START YEAR | END YEAR | KEY TYPE | SW MODULE |
|-------------|-------------|-------------|------------|----------|----------|-----------|
| Europe | Infiniti* | EX37 | 2010 | 2014 | PROX | ADS2159 |
| Europe | Renault* | Kangoo | 2019 | 2019 | BLADE | ADS2325 |
| Europe | Renault* | Mascott | 2003 | 2010 | BLADE | ADS2104 |
| Europe | Toyota* | Corolla | 2019 | 2021 | PROX | ADS2328 |
| Europe | Toyota* | RAV4 | 2012 | 2015 | PROX | ADS2150 |
| Europe | Toyota* | Vitz | 2010 | 2014 | PROX | ADS2150 |
| Africa | Mercedes* | S-Class | 2005 | 2013 | SLOT | ADS2298 |
| Africa | Nissan* | X-Trail | 2013 | 2021 | PROX | ADS2197 |
| Asia | Dodge* | Challenger | 2008 | 2014 | FOBIK | ADS2178 |
| Asia | Dodge* | Nitro | 2007 | 2012 | BLADE | ADS2156 |
| Asia | Renault* | Megane | 2011 | 2016 | CARD | ADS2268 |
| Asia | Volkswagen* | Transporter | 2003 | 2009 | BLADE | ADS2115 |
| Australia | Hyundai* | i30 CN7 | 2020 | 2023 | PROX | ADS2321 |
| Australia | Land Rover* | Freelander | 2013 | 2016 | PROX | ADS2207 |
| Australia | Mazda* | MX-30 | 2021 | 2023 | PROX | ADS2322 |
| Australia | Peugeot* | 2008 | 2013 | 2018 | BLADE | ADS2188 |
| Australia | Peugeot* | 2008 | 2019 | 2023 | PROX | ADS2188 |
| Australia | Toyota* | Fortuner | 2020 | 2023 | BLADE | ADS2174 |
| Australia | Toyota* | Hilux | 2020 | 2023 | BLADE | ADS2174 |
| Canada | Hyundai* | Tucson | 2024 | 2024 | PROX | ADS2280 |
| Middle East | Subaru* | Impreza | 2016 | 2021 | BLADE | ADS2286 |
| S. America | Toyota* | RAV-4 | 2019 | 2020 | PROX | ADS2227 |
| USA | Chevrolet* | Bolt | 2022 | 2023 | PROX | ADS2290 |
| USA | Genesis* | GV90 | 2023 | 2023 | PROX | ADS2321 |

(*) This is a trademark of a third party not affiliated nor linked with Silca S.p.A. or the dormakaba Group. Silca S.p.A. and dormakaba Group do not own any intellectual property right nor have been granted any license with regard to such trademark, which is hereby used only to indicate the intended purpose of Silca's products.

> More info at mykeyspro.com



NEW EMOJI AND USB PEN DRIVE KEY RINGS

New Emoji key rings

Emotions become fun and colourful key rings with the Silca Emoji line: discover the 6 new items of this successful range. The key rings are available in a 12 piece display package (2 pieces per subject) or in bags of 5 pieces of the same design.

Nouveaux porte-clés Emoji

Les émotions deviennent des porte-clés amusants et colorés avec la ligne Silca Emoji: découvrez les 6 nouveautés de cette gamme à succès. Les porte-clés sont disponibles en présentoir de 12 pièces (2 pièces par modèle) ou en sacs de 5 pièces du même design.

Nuovi portachiavi Emoji

Tutte le tue emozioni trasformate in divertenti e colorati portachiavi: scopri i 6 nuovi soggetti della linea Emoji. I portachiavi sono disponibili in espositori da 12 pezzi (2 pezzi per soggetto) o in sacchetti da 5 pezzi per ogni soggetto.

Nuevos llaveros Emoji

Todas las emociones se convierten en llaveros graciosos y de colores: descubre los 6 nuevos sujetos de la línea Emoji. Los llaveros están disponibles en expositores de 12 unidades (2 unidades de cada sujeto) o en bolsas de 5 unidades de cada sujeto.

Neue Emoji-Schlüsselanhänger

Lustige und bunte Schlüsselanhänger, die Emotionen ausdrücken: entdecken Sie die 6 neuen Motive der Linie Emoji.

Die Schlüsselanhänger sind in Ausstellern à 12 Stück (2 Stück pro Motiv) oder in Verpackungen à 5 Stück pro Motiv erhältlich.

Novos porta-chaves Emoji

Transforme todas as suas emoções em porta-chaves divertidos e coloridos: conheça os 6 novos sujeitos da linha Emoji. Os porta-chaves estão disponíveis em expositores de 12 unidades (2 unidades por sujeito) ou em saquinhos de 5 unidades por cada sujeito.

> More info at mykeyspro.com

6 new emoji subjects: collect them all!



Code AVK7262



Code AVK7263



Code AVK7264



Code AVK7265



Code AVK7266



Code AVK7267



Code AVK7296

USB Pen Drive Key rings

USB Pen Drive Keyrings
16GB - 3 colours
12 pieces



Code AVK404095



Complementary Products Catalogue. Discover the New Version 9.0!

You can find more info in the 'Complementary Products' section of The MyKeys Pro or download the catalogue from all Silca websites.

Puoi trovare ulteriori informazioni nella sezione 'Prodotti Complementari' di MyKeys Pro o scaricare il catalogo da tutti i siti Silca.

Weitere Informationen finden Sie unter 'Ergänzende Produkte' von MyKeys Pro oder Sie können den Katalog von allen Silca-Websites herunterladen.

Vous pouvez trouver plus d'informations dans la section 'Produits complémentaires' de MyKeys Pro ou télécharger le catalogue sur tous les sites Silca.

Puede encontrar más información en la sección 'Productos complementarios' de MyKeys Pro o descargar el catálogo de todos los sitios web de Silca.

Você pode encontrar mais informações na seção 'Produtos Complementares' de My Keys Pro ou baixar o catálogo de todos os sites da Silca.

> More info at mykeyspro.com

V6F ROTATING CLAMP

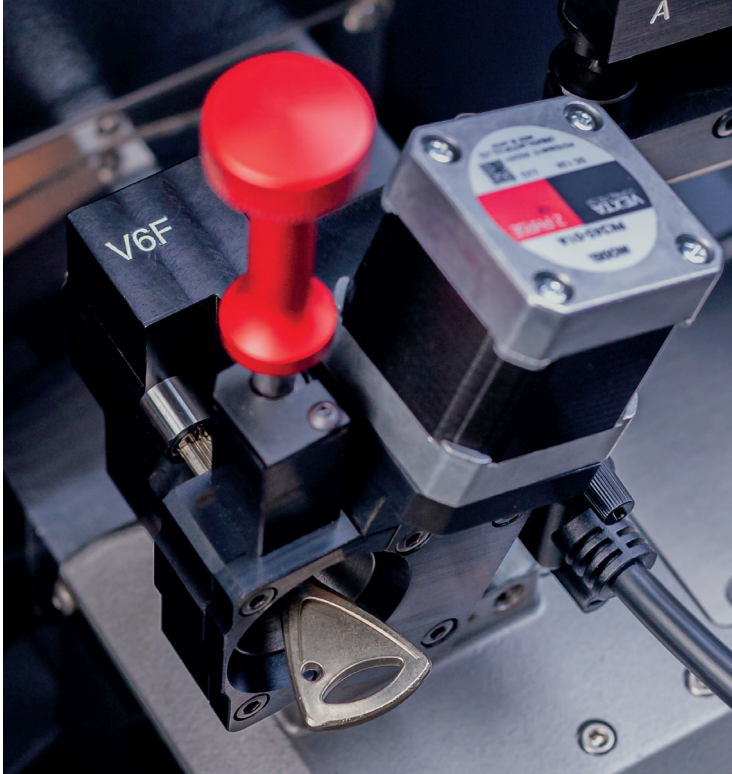

ABLOY*

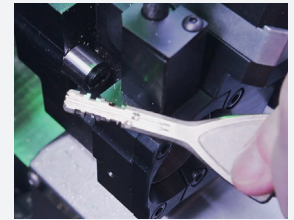
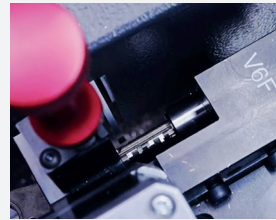
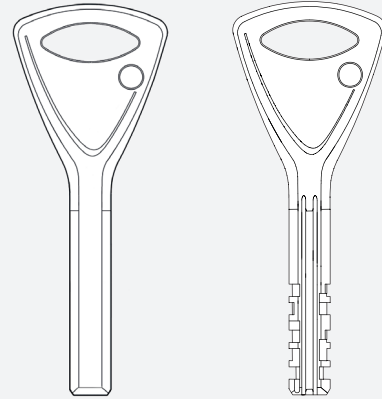

- The V6F rotating clamp is an optional accessory that allows code duplication of Abloy* type keys Protec and Protec 2 systems.
- Il morsetto girevole V6F è un accessorio opzionale che permette la duplicazione a codice di chiavi tipo Abloy* sistemi Protec e Protec 2.
- Die drehbaren Spannbacken V6F ist ein optionales Zubehör, das die Verschlüsselung von Schlüsseln Abloy*-Schlüsseln Systeme Protec und Protec 2 ermöglicht.
- L'étiau pivotant V6F est un accessoire optionnel permettant de dupliquer à code des clés du type Abloy* systèmes Protec et Protec 2.

- La mordaza giratoria V6F es un accesorio opcional que permite la duplicación de códigos de llaves tipo Abloy* sistemas Protec y Protec 2.
- O mordente giratório V6F é um acessório opcional que permite o corte por código de chaves tipo Abloy* sistemas Protec e Protec 2.

UNOCODE F
SERIES



(*) This is a trademark of a third party not affiliated nor linked with Silca S.p.A. or the dormakaba Group. Silca S.p.A. and dormakaba Group do not own any intellectual property right nor have been granted any license with regard to such trademark, which is hereby used only to indicate the intended purpose of Silca's products.

Silca keys blanks are compatible with third-parties manufacturers cylinder specified here below:

ABLOY* (SE)

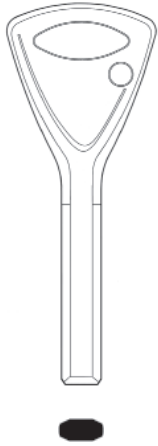

(Protec - Protec 2 Systems)



UNOCODE F100
UNOCODE F400
UNOCODE F600



UNOCODE F800
UNOCODE F900

OPTIONAL

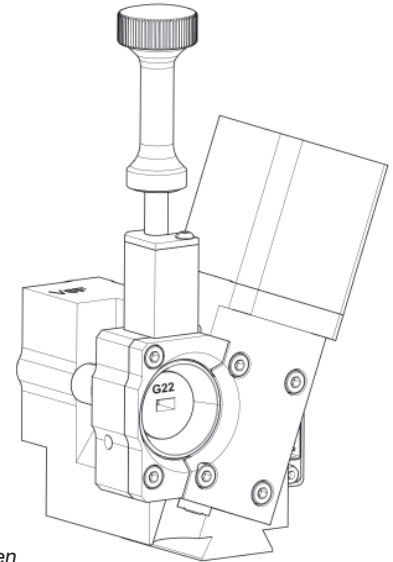

D7A7204ZB

V6F rotating clamp
Morsetto girevole V6F
V6F Drehbarer Spannbacken
Etau pivotant V6F
Mordaza giratoria V6F
Mordente giratorio V6F

System protected by a password issued by Silca on receipt of authorization.
Sistema protetto da password rilasciata da Silca a fronte di autorizzazione.
System geschützt durch von Silca geliefertes Password auf Genehmigung.
Système protégé par un password qui est émis par Silca sur autorisation.
Sistema protegido con contraseña que manda Silca previa autorización.
Sistema protegido por uma password emitida por Silca contra a autorização.

Automatic Feeder

















(*) This is a trademark of a third party not affiliated nor linked with Silca S.p.A. or the dormakaba Group. Silca S.p.A. and dormakaba Group do not own any intellectual property right nor have been granted any license with regard to such trademark, which is hereby used only to indicate the intended purpose of Silca's products.



Futura Software Vers. 3.43.0 - DB 11.03 - Silca App. Vers. 2.9
Futura Pro Software Vers. 3.43.0 - DB 11.03 - Silca App. Vers. 2.9

NEW SYSTEMS

| LOCK MANUFACTURER* | LOCK SYSTEMS* | PROFILE | SERIES | SN | DATA CARD | CLAMP |
|---|--------------------------------------|----------|--|------|-----------|-------------|
| ABUS*  | ABUS* Vela 3000 - Xelus | - | - | 2421 | 5403 | 01R-01J-02J |
| ABUS-PFAFFENHAIN* | ABUS* Z14 (3P) | - | - | 2424 | 5415 | 01R-24J-25J |
| ABUS-PFAFFENHAIN* | ABUS* Z14 (4P) | - | - | 2423 | 5414 | 01R-24J-25J |
| AGB*  | AGB* GENIO | | 0123456789 ABCDEFGHIJ IJKL NOPQRSTUVWXYZ | 2341 | 5220 | 01R-01J-02J |
| AUSFILE* | AUSFILE* PLAIN | | 123 | 9993 | 5411 | 01V |
| EVVA*  | EVVA* AKURA 44 Vario | - | - | 2425 | 5427 | 01R-138-87J |
| FF-FACCHINETTI*  | FACCHINETTI* C19 | | 2370001-2411184 | 2416 | 5399 | 01R-01J-02J |
| GERDA*  | GERDA* EXXO (5+5)(2T-5W) | | 1AK0001-9TK0504 | 2337 | 5219 | 01R-90J-02J |
| GIVI* | GIVI* (4+3) | - | - | 2441 | 5436 | 01R-01J-15J |
| HONDA* | HONDA* Emergency Key (2T-6W) | - | - | 2446 | 5446 | 01R-52J-53J |
| ISEO*  | ISEO* CSF F90 SPI (9000D) | XGA..... | 000001-012882 | 2444 | 5441 | 01R-147-51J |
| ISEO*  | ISEO* CSF F90 SPI (9000N) | XGA..... | 000001-012882 | 2443 | 5440 | 01R-147-51J |
| ISEO*  | ISEO* RME Factory Cantiere/Padronale | NCB..... | 000001-109903 | 2428 | 1597 | 01R-11J-02J |
| ISEO*  | R6 Plus SX2 Cantiere/Padronale | GFB..... | 000001-112540 | 2431 | 5391 | 01R-01J-02J |
| ISEO*  | R6 Plus SX3 Cantiere/Padronale | GHB..... | 000001-112540 | 2434 | 5391 | 01R-01J-02J |
| ISEO*  | R6 Plus SX4 Cantiere/Padronale | GLB..... | 000001-112540 | 2437 | 5391 | 01R-01J-02J |
| ISEO*  | R6 Plus SX5 Cantiere/Padronale | GNB..... | 000001-112540 | 2440 | 5391 | 01R-01J-02J |
| ISEO*  | R6 SPI SX2 | GFC..... | 000001-006056 | 2430 | 5391 | 01R-01J-02J |
| ISEO*  | R6 SPI SX3 | GHC..... | 000001-006056 | 2433 | 5391 | 01R-01J-02J |

(*) This is a trademark of a third party not affiliated nor linked with Silca S.p.A. or the dormakaba Group. Silca S.p.A. and dormakaba Group do not own any intellectual property right nor have been granted any license with regard to such trademark, which is hereby used only to indicate the intended purpose of Silca's products.

> More info on **all Silca websites**



Futura Software Vers. 3.43.0 - DB 11.03 - Silca App. Vers. 2.9
Futura Pro Software Vers. 3.43.0 - DB 11.03 - Silca App. Vers. 2.9

NEW SYSTEMS

| LOCK MANUFACTURER* | LOCK SYSTEMS* | PROFILE | SERIES | SN | DATA CARD | CLAMP |
|--------------------|---------------|----------|---------------|-------|-----------|-------------|
| ISEO* | R6 SPI SX4 | GLC..... | 000001-006056 | 2436 | 5391 | 01R-01J-02J |
| ISEO* | R6 SPI SX5 | GNC..... | 000001-006056 | 2439 | 5391 | 01R-01J-02J |
| ISEO* | R6 SX2 | GFA..... | 000001-039610 | 2429 | 5391 | 01R-01J-02J |
| ISEO* | R6 SX3 | GHA..... | 000001-039610 | 2432 | 5391 | 01R-01J-02J |
| ISEO* | R6 SX4 | GLA..... | 000001-039610 | 2435 | 5391 | 01R-01J-02J |
| ISEO* | R6 SX5 | GNA..... | 000001-039610 | 2438 | 5391 | 01R-01J-02J |
| MERONI* | - | | 1234 | 10000 | 5422 | 01V |
| SANDLEFORD* | - | | 123 | 10001 | 5423 | 01V |

(*) This is a trademark of a third party not affiliated nor linked with Silca S.p.A. or the dormakaba Group. Silca S.p.A. and dormakaba Group do not own any intellectual property right nor have been granted any license with regard to such trademark, which is hereby used only to indicate the intended purpose of Silca's products.

> More info on [all Silca websites](#)



IMPORTANT

In compliance with current regulations relating to industrial property, please note that - but for "Silca", "dormakaba", "Kaba", "Ilco" and "Advanced Diagnostics" - the trademarks or trade names mentioned in our document are the exclusive property of third parties not affiliated nor linked with Silca S.p.A. or the dormakaba Group. Silca S.p.A. and dormakaba Group do not own any intellectual property right nor have been granted any license with regard to such trademarks and trade names, which are hereby used only to indicate the intended purpose of Silca's products. / This catalogue is reserved exclusively for professional key cutters who use Silca products. The illustrations and technical data regarding the products in the document are to be considered indicative. Silca reserves the right to alter products designs, dimensions or info to improve the products quality. The contents of this document are fully protected by Copyright and may not be copied or reproduced in any form, without written permission from Silca S.p.A. Any controversy shall be settled by the Courts where the company Silca S.p.A. has its headquarters, with express exclusion of any other court.

WICHTIG

In Übereinstimmung mit den geltenden Bestimmungen zum gewerblichen Eigentum weisen wir darauf hin, dass - mit Ausnahme von "Silca", "dormakaba", "Kaba", "Ilco" und "Advanced Diagnostics" - die in unserem Dokument erwähnten Markenzeichen oder Handelsnamen das ausschließliche Eigentum Dritter sind, die weder der Silca S.p.A. noch der dormakaba Gruppe angehören oder mit diesen verbunden sind. Diese Markenzeichen oder Handelsbezeichnungen werden hier nur erwähnt, um auf die bestimmungsgemäße Verwendung der Silca-Produkte hinzuweisen. / Dieser Katalog ist ausschließlich professionellen Schlüsseldiensten vorbehalten, die Silca-Produkte verwenden. Die in diesem Dokument enthaltenen Abbildungen und technischen Daten der Produkte sind als Richtwerte zu betrachten. Silca behält sich vor, etwaige Änderungen, die zur Verbesserung des Produktes beitragen, vorzunehmen. Alle Zeichnungen und Fotos sind Eigentum der Firma Silca. Jede Reproduktion, auch teilweise, ist ohne ausdrückliche Genehmigung der Silca S.p.A. gesetzlich untersagt. Im Falle von Streitfragen ist der Gerichtsstand des Firmensitzes Silca S.p.A. zuständig; jeder andere Gerichtsstand ist ausgeschlossen.

IMPORTANTE

En cumplimiento de la normativa vigente en materia de propiedad industrial, se recuerda que, salvo para "Silca", "dormakaba", "Kaba", "Ilco" y "Advanced Diagnostics", las marcas y los nombres comerciales citados en nuestro documento son propiedad exclusiva de terceras sociedades, no afiliadas ni asociadas con Silca S.p.A. o el Grupo dormakaba. Dichas marcas o denominaciones comerciales se citan aquí solamente para indicar el empleo de destino de los productos Silca. / Este catálogo queda reservado exclusivamente a los duplicadores profesionales, que utilizan los productos Silca. Las ilustraciones y los datos técnicos de los productos contenidos en el documento se han de considerar indicativos. Silca se reserva el derecho, quedando invariables las características principales de los productos, de modificar todo lo que considere necesario y oportuno para mejorar la calidad de sus artículos. Todos los dibujos y fotografías pertenecen a Silca; según determina la Ley, se prohíbe toda reproducción, total o parcial, sin autorización por escrito de Silca S.p.A. En caso de disconformidad, la competencia es de las autoridades judiciales donde esté domiciliada la firma Silca S.p.A. excluyendo cualquier otro Tribunal.

IMPORTANTE

In ottemperanza alla normativa vigente in materia di proprietà industriale, si ricorda che - fatta eccezione per "Silca", "dormakaba", "Kaba", "Ilco" e "Advanced Diagnostics" - i marchi o i nomi commerciali citati nel nostro documento sono di esclusiva proprietà di terzi, non affiliati né collegati a Silca S.p.A. o al Gruppo dormakaba. Silca S.p.A. e il Gruppo dormakaba non possiedono alcun diritto di proprietà intellettuale né agli stessi è stata concessa alcuna licenza in relazione a detti marchi o denominazioni commerciali, i quali sono qui citati solo per indicare la destinazione d'uso dei prodotti Silca. / Questo catalogo è riservato esclusivamente ai duplicatori professionisti che utilizzano i prodotti Silca. Le illustrazioni e i dati tecnici dei prodotti contenuti nel documento debbono considerarsi indicativi. Silca si riserva il diritto, ferme restando le caratteristiche essenziali dei prodotti, di apportare tutte le modifiche che ritiene necessarie e opportune al fine di migliorare la qualità dei prodotti. Tutti i disegni e le fotografie sono di proprietà di Silca, ogni riproduzione anche parziale, senza autorizzazione scritta di Silca S.p.A. è vietata secondo termini di legge. Per qualsiasi controversia competenti sono gli Uffici Giudiziari dove ha sede l'Azienda Silca S.p.A., con espressa esclusione di qualsiasi altro foro.

IMPORTANT

Conformément à la législation en vigueur en matière de propriété industrielle, il est rappelé que - à l'exception de "Silca", "dormakaba", "Kaba", "Ilco" et "Advanced Diagnostics" - les marques ou noms commerciaux mentionnés dans notre document sont la propriété exclusive de tiers, non affiliés, ni liés à Silca S.p.A. ou au Groupe dormakaba. Ces marques ou dénominations commerciales ne sont mentionnées ici que pour indiquer la destination des produits Silca. / Ce catalogue est exclusivement réservé aux reproducteurs professionnels qui utilisent les produits Silca. Les illustrations et les données techniques des produits contenues dans le document doivent être considérées comme indicatives. Bien que les caractéristiques essentielles des produits soient invariables, Silca se réserve le droit d'apporter toutes les modifications qu'elle retiendra nécessaires et opportunes afin d'améliorer la qualité de ses produits. Tous les dessins et photos sont propriété Silca et toute reproduction, même partielle, sans l'autorisation écrite préalable de Silca S.p.A. est interdite conformément aux prescriptions légales. Tout litige est du ressort exclusif des Tribunaux de la circonscription où se trouve le Siège de la Société Silca S.p.A.

IMPORTANTE

No respeito das normas em vigor relativas à propriedade industrial, lembra-se que - exceptuando "Silca", "dormakaba", "Kaba", "Ilco" e "Advanced Diagnostics" - as marcas ou os nomes comerciais citados no nosso documento são propriedade exclusiva de terceiros, não associados nem ligados à Silca S.p.A. ou ao Grupo dormakaba. Essas marcas ou denominações comerciais são citadas aqui somente para indicar o uso pretendido dos produtos Silca. / Este catálogo é reservado exclusivamente aos profissionais da duplicação que utilizam os produtos Silca. As figuras e as características técnicas dos produtos contidas no documento são facultadas a título indicativo. Mesmo que as características essenciais dos produtos sejam invariáveis, à Silca reserva-se o direito de modificar ser necessário e oportuno los produtos, afim de melhorar a sua qualidade. Todos os desenhos e fotos são propriedade da Silca, e é proibida a sua reprodução mesmo parcial sem a autorização escrita da Silca S.p.A. conforme as prescrições legais. Em caso de litígio fica desde já designado, excluindo qualquer outro, o Tribunal da comarca onde está registrada a sede da Silca S.p.A.