

# SILCA NEWS

ALL THE NEW KEYS, AUTOMOTIVE SOLUTIONS, KEY CUTTING MACHINES, SOFTWARE UPDATES AND MUCH MORE

2025  
FEBRUARY











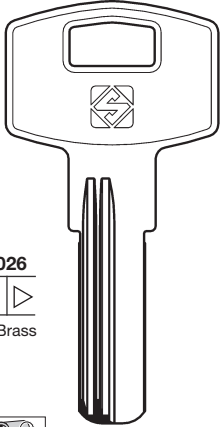

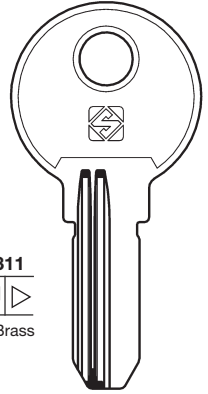

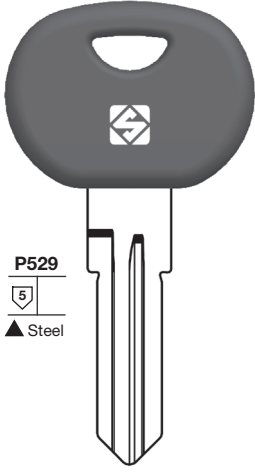

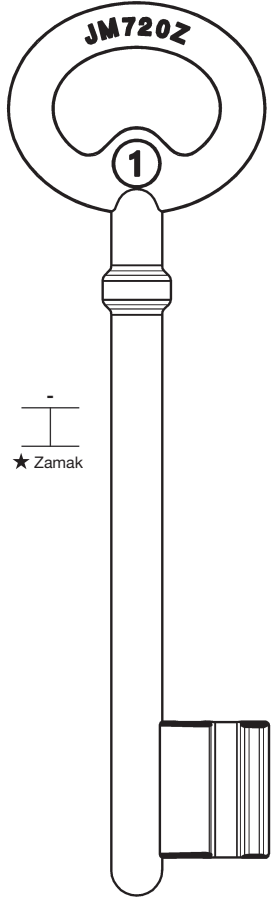













NR.  
02













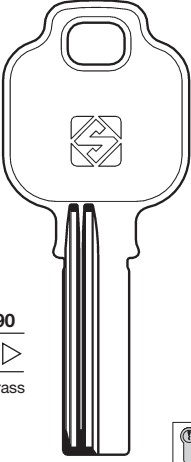

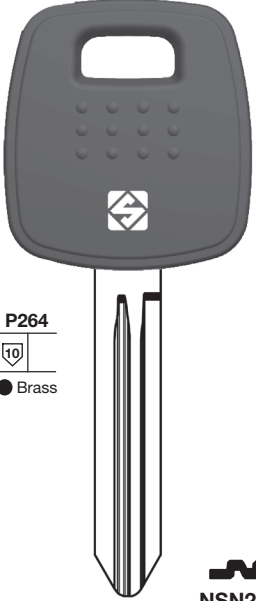

NETWORK WITH US

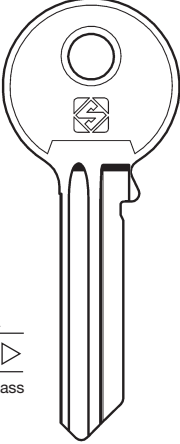

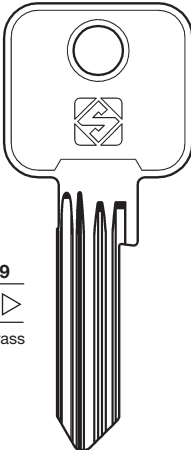
Silca key blanks are compatible with third party manufacturers' cylinders specified here below. Concerning the trademarks and tradenames, please see legal note on the final page.

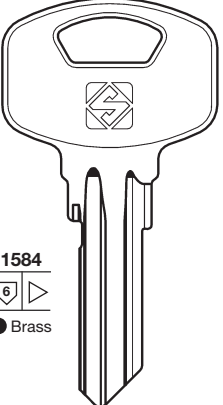
ALMEHRY	DIALL	HUF	
 <p>1026 ● Brass</p>  <p><b>ALY1R</b></p>  <p>8 052782 054049 Box of 50</p>	 <p>1311 ● Brass</p>  <p><b>DIL1R</b></p>  <p>8 052782 053714 Box of 50</p>	 <p>P529 ▲ Steel</p>  <p><b>HU217RP</b></p>  <p>8 052782 055541 Box of 25</p>	<p><b>ALMEHRY (CN)</b></p> <hr/> <p><b>DIALL (FR)</b></p> <hr/> <p><b>HUF (DE)</b></p> <hr/> <p><b>JPM (FR)</b></p> <hr/>
<b>JPM</b>			
 <p><b>JM720Z</b></p> <p>1</p> <p>★ Zamak</p>	 <p><b>JM720Z-1</b></p>  <p>8 052782 056104 Box of 25</p>	 <p><b>JM720Z-2</b></p>  <p>8 052782 056111 Box of 25</p>	 <p><b>JM720Z-3</b></p>  <p>8 052782 056128 Box of 25</p>
	 <p><b>JM720Z-4</b></p>  <p>8 052782 056135 Box of 25</p>	 <p><b>JM720Z-5</b></p>  <p>8 052782 056142 Box of 25</p>	 <p><b>JM720Z-6</b></p>  <p>8 052782 056159 Box of 25</p>
	 <p><b>JM720Z-7</b></p>  <p>8 052782 056166 Box of 25</p>	 <p><b>JM720Z-8</b></p>  <p>8 052782 056173 Box of 25</p>	 <p><b>JM720Z-9</b></p>  <p>8 052782 056180 Box of 25</p>
	 <p><b>JM720Z-10</b></p>  <p>8 052782 056197 Box of 25</p>	 <p><b>JM720Z-11</b></p>  <p>8 052782 056203 Box of 25</p>	 <p><b>JM720Z-12</b></p>  <p>8 052782 056210 Box of 25</p>
	<ul style="list-style-type: none"> <li>● Brass/Ottone/Messing/Laiton/Latón/Latão</li> <li>▲ Steel/Acciaio/Stahl/Acier/Acero/Aço</li> <li>■ Nickel silver/Alpacca Neusilber/Maillechort Alpaca/Alpaca</li> <li>◆ Iron/Ferro/Eisen/Fer/Hierro/Ferro</li> <li>★ Zamak</li> </ul>		
	<ul style="list-style-type: none"> <li>⊙ Color</li> <li>⊕ Silky</li> <li>⊖ Ultralite</li> <li>⊗ Taggy</li> </ul>		

Silca key blanks are compatible with third party manufacturers' cylinders specified here below. Concerning the trademarks and tradenames, please see legal note on the final page.

LOWEN	NISSAN	PARMA	<p>LOWEN (DE)</p> <p>NISSAN (JP)</p> <p>PARMA (IT)</p> <p>POTENT (IT)</p> <p>YALE (IT) (GB)</p>
 <p><b>1590</b></p>  <p>● Brass</p>  <p><b>LOW1R</b></p>  <p>8 052782 052458</p> <p>Box of 50</p>	 <p><b>P264</b></p>  <p>● Brass</p> <p><b>NSN20TE</b></p>  <p>8 052782 053691</p> <p>Box of 5</p>	 <p><b>A</b></p>  <p>● Brass</p> <p><b>PA3</b></p>  <p>8 052782 056623</p> <p>Box of 50</p>	
<p><b>POTENT</b></p>  <p><b>669</b></p>  <p>● Brass</p> <p><b>PT10</b></p>  <p>8 052782 054940</p> <p>Box of 50</p>	<p><b>YALE</b></p>  <p><b>1584</b></p>  <p>● Brass</p>  <p>Shoulder milling view</p> <p><b>YA122SM</b></p>  <p>8 052782 054933</p> <p>Box of 50</p>	<ul style="list-style-type: none"> <li>● Brass/Ottone/Messing/Laiton/Latón/Latão</li> <li>▲ Steel/Acciaio/Stahl/Acier/Acero/Aço</li> <li>■ Nickel silver/Alpacca Neusilber/Maillechort Alpaca/Alpaca</li> <li>◆ Iron/Ferro/Eisen/Fer/Hierro/Ferro</li> </ul> <ul style="list-style-type: none"> <li>⊙ Color</li> <li>⊙ Silky</li> <li>⊙ Ultralite</li> <li>⊙ Taggy</li> </ul>	



Silca key blanks are compatible with third party manufacturers' cylinders specified here below. Concerning the trademarks and tradenames, please see legal note on the final page.

## ZENITH

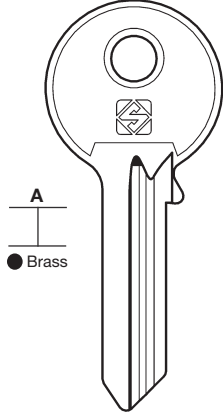

ZT3R



Box of 50

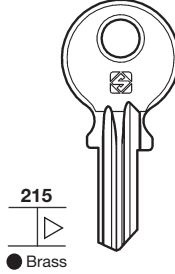

ZT2



Box of 50

### ZENITH (FR) (IT)

● Brass/Ottone/Messing/Laiton/Latón/Latão

▲ Steel/Acciaio/Stahl/Acier/Acero/Aço

■ Nickel silver/Alpacca Neusilber/Maillechort Alpaca/Alpaca

◆ Iron/Ferro/Eisen/Fer/Hierro/Ferro

⊙ Color

⊙ Silky

⊙ Ultralite

⊙ Taggy

## Silca Proximity Car Key TOY53CP42 compatible with Toyota\*

### 🇬🇧 New Proximity Key

Silca is pleased to introduce a new reference for duplicating Toyota Corolla 2019-2022 proximity remotes. The key features two function buttons (lock, unlock) and can be programmed with Smart Pro.



TOY53CP42

Emergency key TOY53

CE The Silca Proximity Car Key TOY53CP42 has been produced in conformity with CE mark European standards.

### 🇮🇹 Nuova Chiave di Prossimità compatibile con Toyota

Silca presenta una nuova referenza per la duplicazione delle chiavi di prossimità compatibile con la Toyota Corolla da 2019 a 2022. La chiave è dotata di due pulsanti (apertura e chiusura centralizzata delle portiere).

### 🇩🇪 Neuer Keyless-Go-Schlüssel kompatibel mit Toyota

Silca präsentiert eine neue Referenz zum Kopieren von Keyless-Go-Schlüsseln, die mit dem Toyota Corolla kompatibel sind. Der Schlüssel hat zwei Tasten (Zentralöffnung und Verriegelung der Türen).

### 🇫🇷 Nouvelle Clé di Proximité compatible avec Toyota

Silca présente un nouvel article pour reproduire des clés de proximité compatibles avec Toyota Corolla 2019-2022. Elle a deux boutons (déverrouillage et verrouillage centralisé des portières).

### 🇵🇹 Nova Chave de Proximidade compatível com Toyota

A Silca apresenta uma nova referência para a duplicação de chaves de proximidade compatíveis com Toyota Corolla. A chave tem dois botões (abertura e fecho centralizado das portas).

### 🇪🇸 Nueva Llave de Proximidad compatible con Toyota

Silca presenta una nueva referencia para la duplicación de llaves de proximidad compatibles con Toyota Corolla. La llave tiene dos botones (apertura y cierre centralizados de las puertas).



Make*	Model	Chassis	From	To	Buttons	Trp ID	Frequency	Silca Profile
Application list for TOY53CP42								
Toyota	Corolla	MZEH12 NRE210 ZWE211	2019	2022	2	49-1E	433FM	TOY53

> More info at [mykeyspro.com](https://mykeyspro.com)

\* This is a trademark of a third party not affiliated nor linked with Silca S.p.A. or the dormakaba Group. Silca S.p.A. and dormakaba Group do not own any intellectual property right nor have been granted any license with regard to such trademark, which is hereby used only to indicate the intended purpose of Silca's products.

## Toyota\* ADS2328 Key Programming Software Update Code D756605AD

### FIRST TO MARKET solution for programming Subaru Solterra proximity keys



**UK** Using Smart Pro and the unique Advanced Diagnostics' emulator and bypass cables, keys can now be programmed for the Subaru Solterra in addition to the various system Toyota and Lexus models previously announced.

**IT** **La PRIMA SOLUZIONE SUL MERCATO per la programmazione delle chiavi di prossimità Subaru Solterra.**

Utilizzando Smart Pro e la gamma unica di emulatori e cavi bypass di Advanced Diagnostics è possibile ora programmare le chiavi per la Subaru Solterra e per vari modelli Toyota e Lexus dotati di sistema immobilizer differente.

**DE** **Die ERSTE AUF DEM MARKT befindliche Lösung zur Programmierung von Subaru Solterra Keyless-Go-Schlüsseln.**

Mit der Smart Pro und der einzigartigen Reihe von Emulator- und Bypass-Kabeln von Advanced Diagnostics können Schlüssel für den Subaru Solterra und verschiedene Toyota- und Lexus-Modelle programmiert werden.

**FR** **La PREMIÈRE SOLUTION SUR LE MARCHÉ pour la programmation des clés de proximité Subaru Solterra.**

Grâce à Smart Pro et à la gamme unique de câbles d'émulateur et de bypass Advanced Diagnostics, les clés peuvent être programmées pour la Subaru Solterra et différents modèles de système Toyota et Lexus.

**PT** **A PRIMEIRA SOLUÇÃO DO MERCADO para a programação de chaves de proximidade Subaru Solterra.**

Utilizando o Smart Pro e a linha exclusiva de emuladores e cabos de bypass da Advanced Diagnostics, as chaves podem ser programadas para do Subaru Solterra e vários modelos de sistemas Toyota e Lexus.

**ES** **Solución PRIMERA EN EL MERCADO para programar llaves de proximidad Subaru Solterra.**

Junto con la Smart Pro y la gama de cables de bypass y de emulacion de llave que ofrece Advanced Diagnostics, se pueden programar llaves para el Subaru Solterra y varios modelos de Toyota y Lexus.

What else is needed?



Smart Pro

Emulator ADC2015

ADC2021

OFFER DETAILS	Using tokens	Using UTP	Using purchased software
Cable	ADC2000	ADC2000	ADC2000
Software category	A	A	A
Smart Aerial+ required	No	No	No
Server connection & key programming	3 tokens	Included	Included

### Applications

Make*	Model*	From	To	Fuel Type	Key Type	Add Key function	All keys lost function	All keys lost + alarm active	Silca key ref	Manufacturer Transponder ID
Subaru	Solterra	2022	2025	Electric	Prox-push button	ADC2021	ADC2015 + ADC2021	ADC2015 + ADC2021	MYKEYS Pro	DST128 AES

> More info at [mykeyspro.com](https://mykeyspro.com)





\* This is a trademark of a third party not affiliated nor linked with Silca S.p.A. or the dormakaba Group. Silca S.p.A. and dormakaba Group do not own any intellectual property right nor have been granted any license with regard to such trademark, which is hereby used only to indicate the intended purpose of Silca's products.



## SKP PRO 1/2025 for Web Subscribers

New cutting cards and series / Nuove schede e serie / Neue Karten und Serien / Nouvelles fiches et séries / Nuevas fichas y series / Novas fichas e séries

## SKP PRO 1/2025 - v. 31.9.0.x - Web Update

QCD/TRIAX PROGRAM	
Lock Manufacturer*	System*
CISA	Cisa RX (MK)
EVA	Ewa DPX (Lateral cut)
IFAM	Ifam PLATINUM M - IRIDIUM M (MKS)
OMEC	Omec Serie 220
OMEC	Omec Serie 240
PIAGGIO	Piaggio (2T-7W)
STAR 	Star 80S (4+4)
TESA 	Tesa T60/T80-3D PL1-16
THIRARD 	Thirard Transit 2 (Fiche 2)
THIRARD 	Thirard Transit 2 (Fiche 3)
TITAN 	HSB

CODE PROGRAM	
Lock Manufacturer*	System*
ICSA	Icsa SGK Modello S2/S3
STAR	Star 80S (5P)
VIRO	VIRO 010Y (4P)
VIRO	VIRO 011Y (4P)
VIRO	VIRO 039 STD (7P)
VIRO	VIRO 061 (5P)
VIRO	VIRO 062 (6P)
VIRO	VIRO 080 STD (5P)
VIRO	VIRO Y.62 (6P)
ZEISS-IKON	Zeiss-Ikon VRS (6P)
ZEISS-IKON	Zeiss-Ikon VRS Mirrored (6P)

(\*) This is a trademark of a third party not affiliated nor linked with Silca S.p.A. or the dormakaba Group. Silca S.p.A. and dormakaba Group do not own any intellectual property right nor have been granted any license with regard to such trademark, which is hereby used only to indicate the intended purpose of Silca's products.

> More info on [all Silca websites](#)

Silca key blanks are compatible with third party manufacturers' cylinders specified here below.

## ZEISS-IKON\*

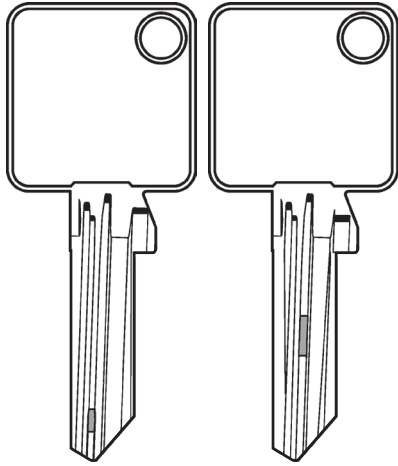

VRS

VRS Mirrored



UNOCODE PRO  
>SW 3.0.034

### OPTIONAL



NEW

### D7A9218ZB

V227 Clamp  
Morsetto V227  
V227 Spannbacke  
Étau V227  
Mordaza V227  
Mordente V227

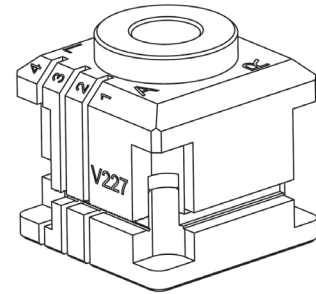

### OPTIONAL



NEW

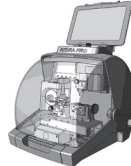

FUTURA PRO  
>SW 3.51.0

### D7A9201ZB

12V Clamp  
Morsetto 12V  
12V Spannbacke  
Étau 12V  
Mordaza 12V  
Mordente 12V

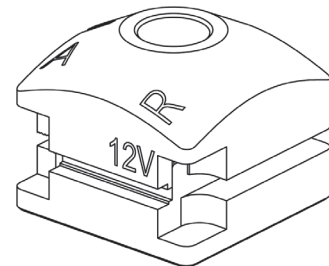

(\*) This is a trademark of a third party not affiliated nor linked with Silca S.p.A. or the dormakaba Group. Silca S.p.A. and dormakaba Group do not own any intellectual property right nor have been granted any license with regard to such trademark, which is hereby used only to indicate the intended purpose of Silca's products.



Silca key blanks are compatible with third party manufacturers' cylinders specified here below.

## ZEISS-IKON\*

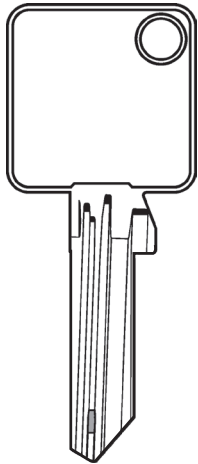

VRS



UNOCODE F800  
UNOCODE F900

OPTIONAL



NEW

### D7A9186ZB

Jaw set U38-L38  
Set ganasce U38-L38  
Satz Backen U38-L38  
Ens.mâchoires U38-L38  
Juego quijadas U38-L38  
Conjunto de garras U38-L38

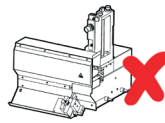
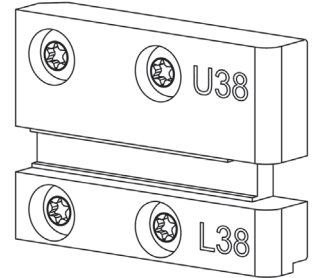

OPTIONAL



NEW



UNOCODE F100  
UNOCODE F400  
UNOCODE F600

### D7A9186ZB

Jaw set U38-L38  
Set ganasce U38-L38  
Satz Backen U38-L38  
Ens.mâchoires U38-L38  
Juego quijadas U38-L38  
Conjunto de garras U38-L38

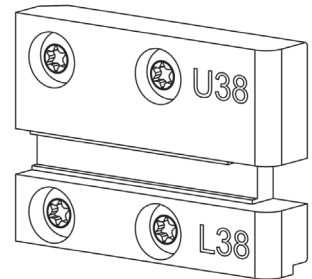

+

OPTIONAL



### D7A3836ZB

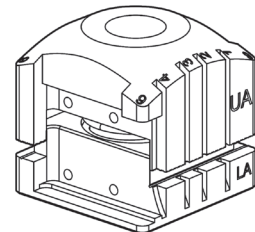

V3 clamp  
Morsetto V3  
V3 Spannbacke  
Etau V3  
Mordaza V3  
Mordente V3



(\* This is a trademark of a third party not affiliated nor linked with Silca S.p.A. or the dormakaba Group. Silca S.p.A. and dormakaba Group do not own any intellectual property right nor have been granted any license with regard to such trademark, which is hereby used only to indicate the intended purpose of Silca's products.

> More info at [mykeyspro.com](http://mykeyspro.com)

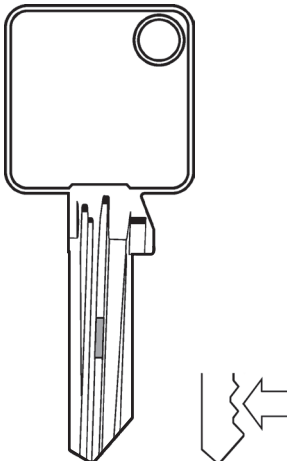
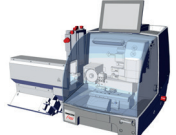
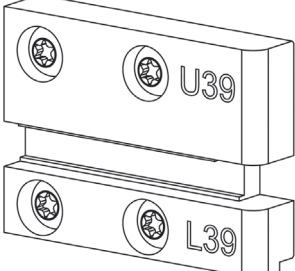
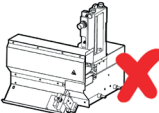
Silca key blanks are compatible with third party manufacturers' cylinders specified here below.

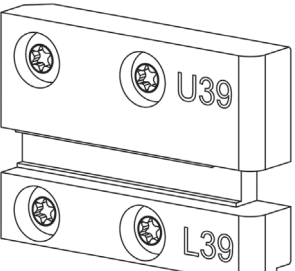
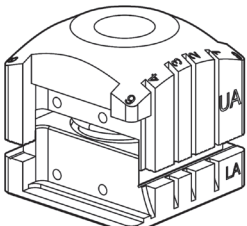
<p><b>ZEISS-IKON*</b></p>  <p>VRS Mirrored</p>	 <p>UNOCODE F800 UNOCODE F900</p>	<p>OPTIONAL ◆ CODE</p> <p><b>D7A9193ZB</b>  <i>Jaw set U39-L39</i>  <i>Set ganasce U39-L39</i>  <i>Satz Backen U39-L39</i>  <i>Ens.mâchoires U39-L39</i>  <i>Juego quijadas U39-L39</i>  <i>Conjunto de garras U39-L39</i></p>   <p><b>NEW</b></p>
	 <p>UNOCODE F100 UNOCODE F400 UNOCODE F600</p>	<p>OPTIONAL ◆ CODE</p> <p><b>D7A9193ZB</b>  <i>Jaw set U39-L39</i>  <i>Set ganasce U39-L39</i>  <i>Satz Backen U39-L39</i>  <i>Ens.mâchoires U39-L39</i>  <i>Juego quijadas U39-L39</i>  <i>Conjunto de garras U39-L39</i></p>  <p><b>NEW</b></p>
		<p>OPTIONAL ◆ CODE</p> <p><b>D7A3836ZB</b>  <i>V3 clamp</i>  <i>Morsetto V3</i>  <i>V3 Spannbacke</i>  <i>Etau V3</i>  <i>Mordaza V3</i>  <i>Mordente V3</i></p> 

(\*) This is a trademark of a third party not affiliated nor linked with Silca S.p.A. or the dormakaba Group. Silca S.p.A. and dormakaba Group do not own any intellectual property right nor have been granted any license with regard to such trademark, which is hereby used only to indicate the intended purpose of Silca's products.

Silca key blanks are compatible with third party manufacturers' cylinders specified here below.

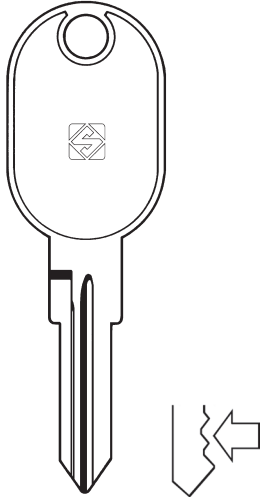

UNOCODE F800  
UNOCODE F900

OPTIONAL

• CODE

**D7A9310ZB**

*Jaw set UC-LC  
Set ganasce UC-LC  
Satz Backen UC-LC  
Ens.mâchoires UC-LC  
Juego quijadas UC-LC  
Conjunto de garras UC-LC*

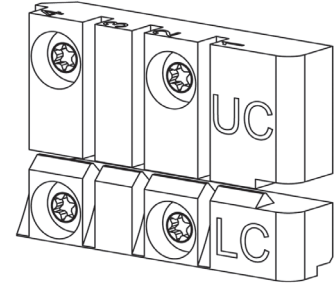
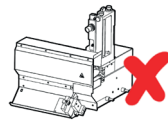

NEW



UNOCODE F100  
UNOCODE F400  
UNOCODE F600

OPTIONAL

• CODE

**D7A9310ZB**

*Jaw set UC-LC  
Set ganasce UC-LC  
Satz Backen UC-LC  
Ens.mâchoires UC-LC  
Juego quijadas UC-LC  
Conjunto de garras UC-LC*

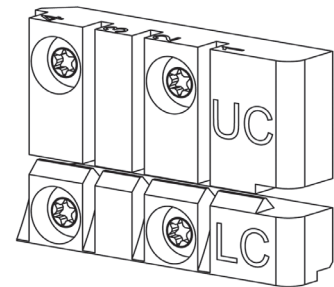

NEW

OPTIONAL

• CODE

**D7A3836ZB**



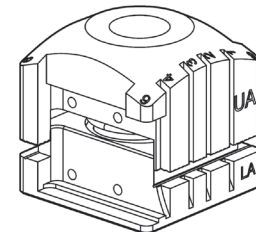

*V3 clamp  
Morsetto V3  
V3 Spannbacke  
Etau V3  
Mordaza V3  
Mordente V3*

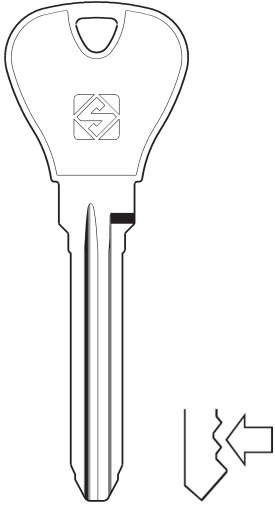

+

(\*) This is a trademark of a third party not affiliated nor linked with Silca S.p.A. or the dormakaba Group. Silca S.p.A. and dormakaba Group do not own any intellectual property right nor have been granted any license with regard to such trademark, which is hereby used only to indicate the intended purpose of Silca's products.

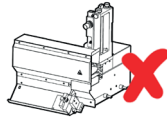
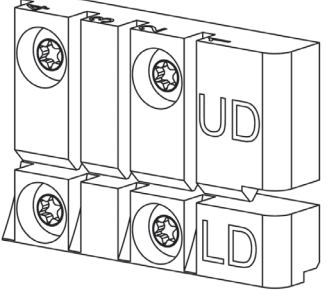
Silca key blanks are compatible with third party manufacturers' cylinders specified here below.

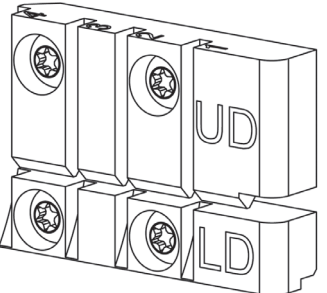
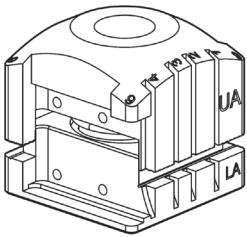
	 <p><b>UNOCODE F800</b> <b>UNOCODE F900</b></p>	<p><b>OPTIONAL</b> ◆ <b>CODE</b></p> <p><b>D7A9446ZB</b>  <i>Jaw set UD-LD</i>  <i>Set ganasce UD-LD</i>  <i>Satz Backen UD-LD</i>  <i>Ens.mâchoires UD-LD</i>  <i>Juego quijadas UD-LD</i>  <i>Conjunto de garras UD-LD</i></p> 	 <p><b>NEW</b></p>
	 <p><b>UNOCODE F100</b> <b>UNOCODE F400</b> <b>UNOCODE F600</b></p>	<p><b>OPTIONAL</b> ◆ <b>CODE</b></p> <p><b>D7A9446ZB</b>  <i>Jaw set UD-LD</i>  <i>Set ganasce UD-LD</i>  <i>Satz Backen UD-LD</i>  <i>Ens.mâchoires UD-LD</i>  <i>Juego quijadas UD-LD</i>  <i>Conjunto de garras UD-LD</i></p>	 <p><b>NEW</b></p>
	+		<p><b>OPTIONAL</b> ◆ <b>CODE</b></p> <p><b>D7A3836ZB</b>  <i>V3 clamp</i>  <i>Morsetto V3</i>  <i>V3 Spannbacke</i>  <i>Etau V3</i>  <i>Mordaza V3</i>  <i>Mordente V3</i></p> 

(\*) This is a trademark of a third party not affiliated nor linked with Silca S.p.A. or the dormakaba Group. Silca S.p.A. and dormakaba Group do not own any intellectual property right nor have been granted any license with regard to such trademark, which is hereby used only to indicate the intended purpose of Silca's products.



**LEGAL NOTES** - In compliance with current regulations relating to industrial property, please note that – but for “Silca”, “dormakaba”, “Kaba”, “Ilco” and “Advanced Diagnostics” – the trademarks or trade names mentioned in our document are the exclusive property of third parties not affiliated nor linked with Silca S.p.A. or the dormakaba Group. Silca S.p.A. and dormakaba Group do not own any intellectual property right nor have been granted any license with regard to such trademarks and trade names, which are hereby used only to indicate the intended purpose of Silca’s products. This catalogue is reserved exclusively for professional key cutters who use Silca products. The illustrations and technical data regarding the products in the document are to be considered indicative. Silca reserves the right to alter products designs, dimensions or info to improve the products quality. The contents of this document are fully protected by Copyright and may not be copied or reproduced in any form, without written permission from Silca S.p.A. For any dispute the competent Court is that of Treviso, the applicable law is that of Italy.

**NOTE LEGALI** - In ottemperanza alla normativa vigente in materia di proprietà industriale, si ricorda che – fatta eccezione per “Silca”, “dormakaba”, “Kaba”, “Ilco” e “Advanced Diagnostics” – i marchi o i nomi commerciali citati nel nostro documento sono di esclusiva proprietà di terzi, non affiliati né collegati a Silca S.p.A. o al Gruppo dormakaba. Silca S.p.A. e il Gruppo dormakaba non possiedono alcun diritto di proprietà intellettuale né agli stessi è stata concessa alcuna licenza in relazione a detti marchi o denominazioni commerciali, i quali sono qui citati solo per indicare la destinazione d’uso dei prodotti Silca. Questo catalogo è riservato esclusivamente ai duplicatori professionisti che utilizzano i prodotti Silca. Le illustrazioni e i dati tecnici dei prodotti contenuti nel documento sono puramente indicativi. Silca si riserva il diritto, ferme restando le caratteristiche essenziali dei prodotti, di apportare tutte le modifiche che ritiene necessarie e opportune al fine di migliorare la qualità dei prodotti. Tutti i disegni e le fotografie sono di proprietà di Silca, ogni riproduzione anche parziale, senza autorizzazione scritta di Silca S.p.A., è vietata secondo termini di legge. Per qualsiasi controversia il foro competente è quello di Treviso, la legge vigente è quella italiana.

**RECHTLICHE HINWEISE** - In Übereinstimmung mit den geltenden Bestimmungen zum gewerblichen Eigentum weisen wir darauf hin, dass – mit Ausnahme von “Silca”, “dormakaba”, “Kaba”, “Ilco” und “Advanced Diagnostics” – die in unserem Dokument erwähnten Markenzeichen oder Handelsnamen das ausschließliche Eigentum Dritter sind, die weder der Silca S.p.A. noch der dormakaba Gruppe angehören oder mit diesen verbunden sind. Diese Markenzeichen oder Handelsbezeichnungen werden hier nur erwähnt, um auf die bestimmungsgemäße Verwendung der Silca-Produkte hinzuweisen. Dieser Katalog ist ausschließlich professionellen Schlüsseldiensten vorbehalten, die Silca-Produkte verwenden. Die in diesem Dokument enthaltenen Abbildungen und technischen Daten der Produkte sind als Richtwerte zu betrachten. Silca behält sich vor, etwaige Änderungen, die zur Verbesserung des Produktes beitragen, vorzunehmen. Alle Zeichnungen und Fotos sind Eigentum der Firma Silca. Jede Reproduktion, auch teilweise, ist ohne ausdrückliche Genehmigung der Silca S.p.A. gesetzlich untersagt. Für alle Streitigkeiten ist das Gericht von Treviso zuständig, das geltende Recht ist italienisch.



**MENTIONS LÉGALES** - Conformément à la législation en vigueur en matière de propriété industrielle, il est rappelé que – à l’exception de “Silca”, “dormakaba”, “Kaba”, “Ilco” et “Advanced Diagnostics” – les marques ou noms commerciaux mentionnés dans notre document sont la propriété exclusive de tiers, non affiliés, ni liés à Silca S.p.A. ou au Groupe dormakaba. Ces marques ou dénominations commerciales ne sont mentionnées ici que pour indiquer la destination des produits Silca. Ce catalogue est exclusivement réservé aux reproducteurs professionnels qui utilisent les produits Silca. Les illustrations et les données techniques des produits contenus dans le document doivent être considérées comme indicatives. Bien que les caractéristiques essentielles des produits soient invariables, Silca se réserve le droit d’apporter toutes les modifications qu’elle retiendra nécessaires et opportunes afin d’améliorer la qualité de ses produits. Tous les dessins et photos sont propriété Silca et toute reproduction, même partielle, sans l’autorisation écrite préalable de Silca S.p.A. est interdite conformément aux prescriptions légales. Pour tout litige, le tribunal compétent est celui de Trévise, la loi en vigueur est italienne.

**AVISOS LEGALES** - En cumplimiento de la normativa vigente en materia de propiedad industrial, se recuerda que – salvo para “Silca”, “dormakaba”, “Kaba”, “Ilco” y “Advanced Diagnostics” – las marcas y los nombres comerciales citados en nuestro documento son propiedad exclusiva de terceras sociedades, no afiliadas ni asociadas con Silca S.p.A. o el Grupo dormakaba. Dichas marcas o denominaciones comerciales se citan aquí solamente para indicar el empleo de destino de los productos Silca. Este catálogo queda reservado exclusivamente a los duplicado-res profesionales, que utilizan los productos Silca. Las ilustraciones y los datos técnicos de los productos contenidos en el documento se han de considerar indicativos. Silca se reserva el derecho, quedando invariables las características principales de los productos, de modificar todo lo que considere necesario y oportuno para mejorar la calidad de sus artículos. Todos los dibujos y fotografías pertenecen a Silca; según determina la Ley, se prohíbe toda reproducción, total o parcial, sin autorización por escrito de Silca S.p.A. Para cualquier litigio el tribunal competente es el de Treviso, la ley vigente es la italiana.

**NOTÍCIAS LEGAIS** - No respeito das normas em vigor relativas à propriedade industrial, lembrese que – exceptuando “Silca”, “dormakaba”, “Kaba”, “Ilco” e “Advanced Diagnostics” – as marcas ou os nomes comerciais citados no nosso documento são propriedade exclusiva de terceiros, não associados nem ligados à Silca S.p.A. ou ao Grupo dormakaba. Essas marcas ou denominações comerciais são citadas aqui somente para indicar o uso pretendido dos produtos Silca. Este catálogo é reservado exclusivamente aos profissionais da duplicação que utilizam os produtos Silca. As figuras e as características técnicas dos produtos contidas no documento são facultadas a título indicativo. Mesmo que as características essenciais dos produtos sejam invariáveis, à Silca reserva-se o direito de modificar ser necessário e oportuno los productos, afim de melhorar a sua qualidade. Todos os desenhos e fotos são propriedade da Silca, e é proibida a sua reprodução mesmo parcial sem a autorização escrita da Silca S.p.A. conforme as prescri-ções legais. Para qualquer litígio o tribunal competente é o de Treviso, a lei vigente é a italia na.