



Look A-like Keys with GTI Transponder

Edition
NOVEMBER
2017



🇬🇧 SILCA LOOK A-LIKE KEYS RANGE

GTI is compatible with the new Silca Look A-like transponder keys series: a vehicle keys range with key head design identical to the original.

You will be able to easily recognize Silca Look A-like keys range thanks to the reference ending in TE (eg. F010TE).

- Key head design identical to the original.
- Wide and continuously updated keys range.

🇮🇹 GAMMA CHIAVI SILCA LOOK A-LIKE

GTI è compatibile con la nuova serie di chiavi transponder Silca Look A-like: una gamma di chiavi veicolo con design della testa identica alla chiave originale.

Potrai riconoscere facilmente le chiavi della gamma Silca Look A-like per la referenza terminante in TE (es. F010TE).

- Design testa chiave identica all'originale.
- Gamma di referenze ampia e in continuo aggiornamento.

🇩🇪 SCHLÜSSEL SILCA LOOK A-LIKE

GTI kann mit den neuen Silca Look A-Like Transponder Schlüsseln verwendet werden: die Fahrzeugschlüssel mit Kopf-Design entsprechend dem Original-Schlüssel.

Die Look A-like Schlüssel sind einfach erkennbar dank den Buchstaben "TE" am Ende der Artikelnummer (z.B. F010TE).

- Dem Original entsprechendes Schlüssel-Kopf-Design.
- Reichhaltig Schlüssel-Sortiment mit dauernder Erweiterung.

🇫🇷 GAMME CLÉS SILCA LOOK A-LIKE

GTI est compatible avec la nouvelle série de clés transpondeur Silca Look A-like: une gamme de clés pour véhicule avec un design de la tête identique à la clé originale. Vous pourrez reconnaître facilement les clés de la gamme Silca Look A-like par la référence, qui terminera avec TE (Ex: F010TE).

- Design tête clé identique à l'originale.
- Gamme de références ample et continuellement mise à jour.

🇪🇸 GAMA LLAVES SILCA LOOK A-LIKE

GTI es compatible con la nueva serie de llaves transponder Silca Look A-like: una gama llaves vehículo con el mismo design de la llave original.

Podrá reconocer las llaves de la gama Silca Look A-like a través de la referencia que termina por TE (es. F010TE).

- Design de la cabeza llave idéntico al original.
- Gama referencias amplia y en continua evolución.

🇵🇹 LINHA DE CHAVES SILCA LOOK A-LIKE

O transponder GTI é compatível com a nova linha de chaves transponder Silca Look A-like: uma linha de chaves para veículos com o formato da cabeça igual às chaves originais. Você será capaz de reconhecer a linha de chaves Look A-like graças à referência que acaba sempre em TE (ex.: F010TE).

- Formato da cabeça da chave igual à chave original.
- Ampla linha de chaves, atualizada constantemente.

Transponder components / Componenti Transponder / Transponderkomponenten / Composants Transponder / Componentes Transponder

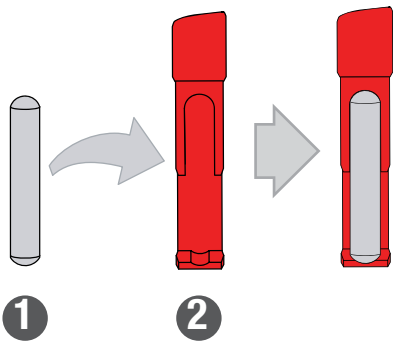

Code / Codice / Código: **C03313**

- | | |
|---|---|
| 1 GTI Transponder
Transponder GTI
Transpondeur GTI
Transponder GTI
Transponder GTI | 2 Transponder adapter
Adattatore transponder
Transponder adapter
Adaptateur pour transpondeur
Adaptador para transponder
Adaptador para transponder |
|---|---|

Transponder Key and GTI / Chiave Transponder e GTI / Transponderschlüssel und GTI / Clé Transpondeur et GTI / Llave Transponder y GTI / Chave Transponder e GTI

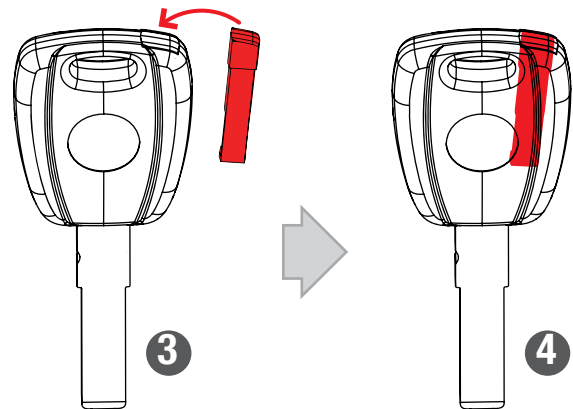

Code / Codice / Código: **SIP22TE**

- | | |
|--|--|
| 3 Transponder key without GTI
Chiave transponder senza GTI
Transponderschlüssel ohne GTI
Clé transpondeur sans GTI
Llave transponder sin GTI
Chave transponder sem GTI | 4 Transponder key with GTI inside
Chiave transponder con GTI inserito
Transponderschlüssel mit GTI eingefügt
Clé transpondeur avec GTI inséré
Llave transponder con GTI insertado
Chave transponder com GTI inserido |
|--|--|



Look A-like Keys with GTI Transponder

Edition
NOVEMBER
2017

FO38RTE

FORD USA	→	→
EXPLORER	2011	2015
EXPLORER SPORT	1999	2001
EXPLORER SPORT TRAC	2001	2010
FIVE HUNDRED	2005	2008
FLEX	2009	2010
FLEX	2009	2012
FLEX	2011	2012
FLEX	2011	
FOCUS	2000	2005
FOCUS	2006	2011
FOCUS	2011	2011
FORD GT	2005	2006
FREESTAR	2004	2007
FREESTYLE	2005	2008
FUSION	2006	2012
FUSION	2011	2012
F-150	1999	2004
F-150	2004	2008
F-150	2004	2010
F-150	2009	2010
F-150	2011	2014
F-250	1999	2004
F-250	2004	2008
F-250	2004	2010
F-250	2008	2010
F-250	2011	
F-350	1999	2003
F-350	2004	2008
F-350	2004	2010
F-350	2011	2016
F-450	2004	2010
F-450	2011	2016
LTD	1998	2003
MUSTANG	1996	2004
MUSTANG	1996	1997
MUSTANG	1998	2004
MUSTANG	2005	2012
MUSTANG	2011	2014
MUSTANG COBRA	1997	1997
RANGER	1999	2000
RANGER	2001	2012
RANGER	2011	2012
RANGER XLT V6	1999	2000
TAURUS	1996	1999
TAURUS	2000	2003
TAURUS	2004	2008
TAURUS	2008	2011
TAURUS	2011	
TAURUS SHO & LS	1996	1997
TAURUS SHO & LS	1996	1999
TAURUS SHO & LS	1998	1999
THUNDERBIRD	2002	2002
THUNDERBIRD	2003	2005
WINDSTAR	1998	2000
WINDSTAR	2001	2003
LINCOLN	→	→
AVIATOR	2003	2007
BLACKWOOD	2002	2002
CONTINENTAL	1998	2002
CONTINENTAL	2002	2004
LS	2000	2006
LS	2003	2006
MARK LT	2006	2008
MARK LT	2011	2014
MKT	2010	2011
MKX	2007	2011
MKX	2011	2013
MKZ	2007	2011
MKZ	2011	
NAVIGATOR	1997	1998
NAVIGATOR	1998	2002
NAVIGATOR	2003	2011
NAVIGATOR	2009	
TOWN CAR	1998	2002
TOWN CAR	2003	2012
ZEPHYR	2006	2009
MAZDA	→	→
B-SERIES P/U	1999	2000
B-SERIES P/U	2007	2009
TRIBUTE	2005	2011
MERCURY	→	→
GRAND MARQUIS	1998	2002
GRAND MARQUIS	2003	2011
MARAUDER	2003	2005
MARINER	2005	2007
MARINER	2005	2011
MARINER	2007	2011
MILAN	2006	2011
MONTEGO	2005	2008
MONTEREY	2004	2007
MOUNTAINEER	1998	2001
MOUNTAINEER	2002	2011
SABLE	2008	2009
SABLE GS	1999	1999
SABLE GS	1999	2000
SABLE GS, LS	1996	1999
SABLE GS, LS	2000	2007
SABLE LS, SE, SHO	1996	1997
SABLE LS, SE, SHO	1996	1999
SABLE LS, SE, SHO	1998	1999
PANOZ	→	→
ESPERANTE	2001	2006
ESPERANTE	2007	2010
VPG	→	→
MV-1	2012	2014

FO42RTE

For/Per/Für/Pour/Para:		
FORD AUS	→	→
ESCAPE	2009	2013
GM45TE	→	→
For/Per/Für/Pour/Para:		
CHEVROLET USA	→	→
CAPRICE PPV	2011	2013
HOLDEN	→	→
COMMODORE VE	2006	
PONTIAC	→	→
G8	2008	2009
GT10BTE	→	→
For/Per/Für/Pour/Para:		
CITROËN	→	→
JUMPER	1996	2001
RELAY	1996	2001
FIAT	→	→
CINQUECENTO	1995	1996
CROMA	1995	1997
DUCATO	1996	2001
FIORINO	1995	2002
PANDA	1995	2002
IVECO	→	→
35C11	2000	
DAILY	1998	2006
DAILY	2006	2011
EUROSTAR	1998	2002
S-2000	1998	
PEUGEOT	→	→
BOXER	1996	2001
GT15RBTE	→	→
For/Per/Für/Pour/Para:		
FIAT	→	→
BRAVA	1995	1996
BRAVO	1995	1996
CINQUECENTO	1997	1998
MARENGO	1996	2001
SEICENTO	1997	2000
SEICENTO	2000	2010
TEMPRA	1995	1996
GT15RTE	→	→
For/Per/Für/Pour/Para:		
FIAT	→	→
MULTIPLA	1998	2010
PALIO	2002	2010
PUNTO	1999	2005
SIENA	2002	2011

HON58RTE

For/Per/Für/Pour/Para:		
ACURA	→	→
CL	1998	2003
EL	2001	2002
INTEGRA	2000	2001
MDX	2001	2006
NSX	1997	2005
RL	1996	2004
RL	2005	2010
RSX	2002	2006
TL	1999	2003
TL	2004	2006
TSX	2004	2008
HOLDEN	→	→
FRONTERA	1999	2004
HONDA	→	→
ACCORD	1999	2002
ACCORD AERODECK	1995	1997
ACCORD COUPE	1995	2002
CIVIC	1995	1999
CIVIC	1999	2002
CR-V	1997	1999
CR-V	1999	2001
GOLD WING	2001	
HR-V	1999	2005
INSIGHT	2001	2005
INTEGRA	1998	2001
LEGEND	1996	2005
LOGO	1999	2001
NSX	1997	2005
PASSPORT	1998	2002
PRELUDE	1997	2001
SHUTTLE	1995	2000
SHUTTLE	2000	2003
STREAM	2001	2003
S2000	2000	2003
HONDA USA	→	→
ACCORD	1998	2002
CIVIC	2001	2002
INSIGHT	2000	2006
ODYSSEY	1998	2002
PRELUDE	1997	2002
S2000	2000	2003
ISUZU	→	→
AXIOM	2003	2004
RÔDEO	1999	2004
OPEL-VAUXHALL	→	→
FRONTERA	1999	2003
HON65RTE	→	→
For/Per/Für/Pour/Para:		
HONDA	→	→
ACCORD	1999	2002
HON66TE	→	→
For/Per/Für/Pour/Para:		
ACURA	→	→
CSX	2006	2011
EL	2003	2005
MDX	2007	2013
RDX	2007	2012
TL	2007	2014
TSX	2009	2014
ZDX	2010	2012
HONDA	→	→
ACCORD	2003	2006
ACCORD	2006	2008
ACCORD	2008	
AIRWAVE [J]	2005	2010
AMAZE	2010	

HON66TE

For/Per/Für/Pour/Para:		
HONDA	→	→
BRIO	2010	
CITY	2002	2007
CITY	2008	2013
CIVIC	2002	2005
CIVIC	2006	2014
CIVIC	2014	
CIVIC (AUSTRALIA)	2002	2005
CIVIC (AUSTRALIA)	2003	
CR-V	2002	2006
CR-V	2007	2014
CR-V	2014	
CR-V (AUSTRALIA)	2002	2006
CR-Z	2010	
EDIX [J]	2004	2007
EDIX [J]	2007	2009
ELYSION [J]	2004	2013
FR-V	2004	2007
FR-V	2007	2011
INSIGHT	2009	
JAZZ	2001	2007
JAZZ	2006	2008
JAZZ	2009	2014
JAZZ	2015	
JAZZ (AUSTRALIA)	2001	
LEGEND	2007	2012
MDX (AUSTRALIA)	2003	
PARTNER [J]	2006	2010
STEPWGN	2005	2009
STREAM	2003	2007
STREAM	2008	
S2000	2004	2005
S2000	2006	2010
HONDA USA	→	→
ACCORD	2003	2012
CIVIC	2003	2005
CIVIC	2006	2013
CIVIC	2014	
CROSSTOUR	2010	2012
CR-V	2002	2006
CR-V	2007	2013
CR-Z	2011	2014
ELEMENT	2003	2005
ELEMENT	2006	2011
FIT	2007	2008
FIT	2009	2014
INSIGHT	2010	2014
ODYSSEY	2003	2004
ODYSSEY	2005	
PILOT	2003	2005
PILOT	2006	2015
RIDGELINE	2006	2014
S2000	2004	2005
S2000	2006	2007
S2000	2008	2009
VOLKSWAGEN S.AMERICA	→	→
FOX SPORTVAN	2006	2010
HON70TE	→	→
For/Per/Für/Pour/Para:		
HONDA	→	→
BLACK SPIRIT	2010	
CBF 600	2007	2012
CBR 600F	1999	2006
CBR 600RR	2003	
CBR 900	2003	
CBR 1000	2004	
CBR 1100XX	1999	2006
CROSSRUNNER	2011	
CROSSTOURER	2012	
CTX 700	2014	
CTX 1300	2014	
HORNET	2003	
INTEGRA	2012	2015
NC 700 S	2012	2014
NC 700 X	2012	2014
NC 750	2014	
NT 650V	1999	2006
NT 700V	2006	2012
SHADOW 750	2004	
SILVER WING	2001	2008
ST1300 Pan-European	2008	
SW-T400	2009	
SW-T600	2011	
VARADERO	2003	
VFR 800	2006	
VFR 1200	2009	
VT 750 C4	2004	2010
VT 1300CX	2009	
VTX 1800C	2002	
X-ELEVEN	2001	2003

HU100TE

CHEVROLET USA		
CAMARO	2010	
CAPRICE PPV	2014	
COLORADO	2015	
CRUZE	2011	
EQUINOX	2010	
EXPRESS	2015	
IMPALA	2014	
MALIBU	2014	
ORLANDO	2012	2014
SILVERADO	2014	
SONIC	2012	
SUBURBAN	2015	
TAHOE	2015	
TRAX (CANADA)	2013	
VOLT	2011	2015
GMC (GM)		
CANYON	2015	
DENALI	2015	
SAVANA	2015	
SIERRA	2014	
TERRAIN	2010	
YUKON	2015	
HOLDEN		
ASTRA	2004	
VECTRA	2004	
ZAFIRA	2004	
OPEL-VAUXHALL		
ADAM	2013	
AGILA	2004	2008
AMPERA	2012	
ASTRA	2004	
CABRIO	2013	
CASCADA	2013	
COMBO	2007	2011
CORSA	2004	2006
CORSA	2006	2013
CORSA	2006	
INSIGNIA	2008	
MERIVA	2004	2010
MERIVA	2010	
MOKKA	2012	2014
SIGNUM	2003	2008
TIGRA	2004	2009
VECTRA	2004	2008
ZAFIRA	2006	
SATURN (GM)		
ASTRA	2008	2009

HU101TE

For/Per/Für/Pour/Para:		
FORD AUS		
BF FALCON	2005	2010
FOCUS	2005	
TERRITORY	2005	2010
FORD EU		
B-MAX	2012	
C-MAX	2011	
ECOSPORT	2013	
EDGE	2011	2013
FIESTA	2008	2012
FIESTA	2013	
FOCUS	2004	2010
FOCUS	2011	
FOCUS C-MAX	2003	2010
GALAXY	2006	2010
GALAXY	2010	2014
KUGA	2008	2012
KUGA	2012	
MONDEO	2007	2010
MONDEO	2011	2014
RANGER	2012	
S-MAX	2006	2010
S-MAX	2010	2014
TOURNEO CONNECT	2013	
TOURNEO COURIER	2012	
TOURNEO CUSTOM	2013	
TRANSIT	2013	
FORD S.AMERICA		
ECOSPORT	2012	
MONDEO	2007	
FORD USA		
C-MAX	2013	
ESCAPE	2012	2012
FIESTA	2011	
FIESTA	2011	
FOCUS	2012	
FUSION	2013	
TRANSIT CONNECT	2014	
TRANSIT	2013	
LAND ROVER		
DISCOVERY 3	2006	2009
RANGE ROVER SPORT	2006	2009
MAZDA		
BT-50	2011	

HU116TE

For/Per/Für/Pour/Para:		
DODGE		
SPRINTER	2007	2013
VOLKSWAGEN		
CRAFTER	2006	

HU133RTE

For/Per/Für/Pour/Para:		
FIAT		
SEDICI	2006	
SEDICI DIESEL	2006	
MARUTI SUZUKI		
ALTO K10	2010	
A-STAR	2007	
RITZ	2007	
SWIFT	2007	
SWIFT [D]	2007	2009
SX4	2007	
WAGON R	2010	
NISSAN		
PIXO	2009	
OPEL-VAUXHALL		
AGILA	2008	
AGILA DIESEL	2008	
SUZUKI		
ALTO	2009	
GRAND VITARA	2008	2013
GRAND VITARA (AUS)	2005	2013
IGNIS	2003	2008
JIMNY	2002	2015
SPLASH	2008	2015
SPLASH DIESEL	2008	2015
SWIFT	2005	
SX4	2006	2013
SX4 DIESEL	2006	2013

HU134TE

For/Per/Für/Pour/Para:		
KIA		
VENGA	2010	

HU136TE

For/Per/Für/Pour/Para:		
RENAULT-DACIA		
DOKKER	2012	
LODGY	2012	
SANDERO	2010	2013

HYN6TE

For/Per/Für/Pour/Para:		
HYUNDAI		
ACCENT	1999	2011
AVANTE	2000	2006
COUPE	1996	2001
COUPE	2001	2009

HYN6TE

HYUNDAI		
ELANTRA	1999	2000
ELANTRA	2000	2006
EXCEL	1999	2000
GALLOPER	1999	2003
GETZ	2002	2009
H-1	1999	2006
H-1	2006	2007
INNOVATION	1999	2003
LANTRA	1996	2000
LANTRA	2000	2006
LAVITA	2001	2010
MATRIX	2002	2010
SANTA FE	2002	2006
SANTA FE (CANADA)	2002	2006
SANTAMO	2000	2003
SCOUPE		1996
TERRACAN	2001	2007
TIBURON	2001	2010
TUCSON	2004	2010
TUCSON (CANADA)	2005	2009
VERNA	1999	2010
KIA		
MORNING	2006	2011
PICANTO	2004	2008
RIO (USA)	2006	2009
RIO (USA)	2010	2017
SPORTAGE	2006	2010

HYN7RTE

For/Per/Für/Pour/Para:		
HYUNDAI		
GRANDEUR XG (AUS)	1998	2005
SANTA FE	2000	2002
SONATA	1996	1998
SONATA	1998	2004
SONICA	1996	1998
SONICA	1996	1999
SONICA	1999	2004
TRAJET	1999	2007
TRAJET	2000	2006
XG25/XG30	1998	2005
XG300 (CANADA)	2002	2005
KIA		
SORENTO	2002	2009

HYN10TE

For/Per/Für/Pour/Para:		
HYUNDAI		
ACCENT	1996	1999
AMICA	1997	2001
AMICA	2004	2008
ATOS	1997	2000
ATOS PRIME	1999	2001
ATOS PRIME	2002	2008
EXCEL	1996	1999
PONY	1995	1999
VERNA	1996	1999

HYN12TE

For/Per/Für/Pour/Para:		
HYUNDAI		
STAREX	1998	2006

HYN14TE

For/Per/Für/Pour/Para:		
HYUNDAI		
AVANTE	2007	2011
ENTOURAGE	2007	2009

HYN14TE

HYUNDAI		
H-1	2007	2015
H-1 BUS	2007	2015
I10	2008	2013
iLOAD	2007	2014
iMAX	2007	2014
STAREX	2007	
KIA		
CARENS	2006	2013
CARNIVAL	2006	2014
OPTIMA	2006	2010
SEDONA	2006	2014
SSANGYONG		
KORANDO	2010	2012

HYN14RTE

For/Per/Für/Pour/Para:		
HYUNDAI		
ELANTRA	2007	2016
ENTOURAGE (USA)	2007	2008
GENESIS C.PE	2010	2014
SANTA FE	2006	2012
SANTA FE (CANADA)	2007	2010
SONATA	2005	2010
TUCSON (CANADA)	2010	2012
VERACRUZ	2007	2012
VERACRUZ (CANADA)	2007	2010
KIA		
FORTE (CDN)	2010	2013
FORTE (USA)	2010	
FORTE KOUP	2010	2013
MAGENTIS	2006	2008
RONDO	2007	2010
SOUL	2009	2013
SOUL (USA)	2010	2013

HYN15TE

For/Per/Für/Pour/Para:		
KIA		
RIO	2006	2009
RIO (CANADA)	2006	2009

HYN17BTE

For/Per/Für/Pour/Para:		
HYUNDAI		
ACCENT (AUS)	2012	
VELOSTER	2010	
VELOSTER (AUS)	2012	
KIA		
PICANTO	2011	

HYN17RBTE

For/Per/Für/Pour/Para:		
HYUNDAI		
SANTA FE	2013	
SANTA FE (AUS)	2013	



Look A-like Keys with GTI Transponder

Edition
NOVEMBER
2017

ISU5TE



For/Per/Für/Pour/Para:		
ISUZU	→	→
ELF	2009	
F-SERIES	2009	
N-SERIES	2009	

KIA3RTE

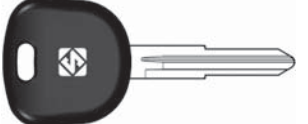

For/Per/Für/Pour/Para:		
KIA	→	→
CARENS	2001	2006
CARNIVAL	1999	2000
CARNIVAL	2000	2002
CARNIVAL	2002	2005
CLARUS	1998	2001
JOICE	2000	2003
MAGENTIS	2001	2006
MENTOR	2002	2004
OPTIMA	2001	2006
PRIDE	1999	2001
RETONA	1998	2003
RETONA	1999	2003
RIO	2001	2005
RONDO	2001	2006
SEDONA	1999	2000
SEDONA	2002	2005
SEPHIA	1997	2003
SEPHIA	2002	2004
SHUMA	1998	2001
SHUMA	2000	2001
SPORTAGE	1998	1999
SPORTAGE	1999	2001
SPORTAGE	2001	2003

KW16TE

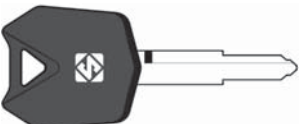

For/Per/Für/Pour/Para:		
KAWASAKI	→	→
NINJA ZX-6R	2006	
NINJA ZX-10R	2004	2010
NINJA ZX-12R	2002	2006
NINJA ZX-14R	2006	2011
ZZR1200	2002	2006
ZZR1400	2007	2011
Z750S	2006	
Z1000	2004	2009

MAZ24RTE

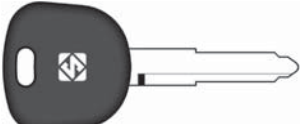

For/Per/Für/Pour/Para:		
MAZDA	→	→
323	1997	1999
323	1998	1999
626 6CYL. (USA)	1998	1999
CX-5	2012	2014
CX-7	2006	2012
CX-9	2007	
DEMIO [J]	2003	
DEMIO [J]	2003	2014
MAZDA 2	2003	2014
MAZDA 3	2004	2013
MAZDA 5	2005	2015
MAZDA 6	2003	2012
MX-5	1998	2000
MX-5	2005	2015
RX-8	2004	2012

MIT8TE

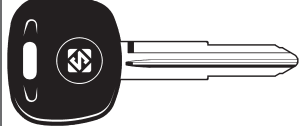

For/Per/Für/Pour/Para:		
MITSUBISHI	→	→
CHALLENGER	1999	2002
CHALLENGER	2002	2003
DIAMANTE	2001	2006
ECLIPSE	1996	2000
ECLIPSE	2001	2005
EXPRESS	1996	2002
FOCUS	1998	2002
GALANT	1996	2000
GALANT	2002	2005
L200	2002	2006
L200	2006	
MONTERO	1996	2000
MONTERO	2001	2006
MONTERO	2002	2003
MONTERO	2006	2014
MONTERO SPORT	2000	2000
MONTERO SPORT	2001	2004
MONTERO SPORT	2001	2006
MONTERO SPORT	2007	2014
NATIVA	2008	2014
NIMBUS	1998	1999
OUTLANDER	2000	2003
PAJERO	1996	2000
PAJERO	2000	2002
PAJERO	2002	2005
PAJERO	2002	2003
PAJERO	2006	
PAJERO SPORT	1999	2002
PAJERO SPORT	2002	2003
PAJERO SPORT	2002	2006
SHOGUN	1996	2000
SHOGUN	2000	2002
SHOGUN	2002	2003
SHOGUN	2002	2005
SHOGUN SPORT	1999	2002
SHOGUN SPORT	2002	2003
SPACE GEAR	1996	2002
SPACE RUNNER	1998	1999
SPACE RUNNER	1999	2005
SPACE WAGON	1998	1999
SPACE WAGON	1999	2003
TRITON	2002	2006
TRITON	2006	2015
VERADA	2002	2003

MIT11RTE

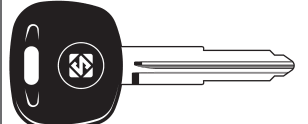

For/Per/Für/Pour/Para:		
CITROËN	→	→
C-CROSSER	2007	2012
C-ZERO	2011	
MITSUBISHI	→	→
380	2006	
ASX	2010	
COLT	1996	2000
COLT	2000	2004
COLT	2005	2010
ECLIPSE (USA)	2008	2012
ENDEAVOR	2007	2011
GALANT	2006	2012
GALANT (USA)	2008	2012
GRANDIS	2003	2011
I-MIEV	2010	
LANCER	1996	2003
LANCER	2003	2006
LANCER	2007	
LANCER EVO	2003	2006
LANCER SW	1996	2003
MIRAGE	1996	2002
MIRAGE	2012	
MONTERO IO	2000	2006
OUTLANDER	2004	2008
OUTLANDER	2007	
OUTLANDER SPORT	2011	
PAJERO IO	1999	2004
PAJERO MINI [J]	1999	
PAJERO PININ	1999	2004
RVR (CANADA)	2011	2014
SHOGUN PININ	1999	2004
PEUGEOT	→	→
4007	2007	2012
ION	2011	

MIT17TE

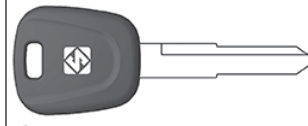

For/Per/Für/Pour/Para:		
MITSUBISHI	→	→
FUSO	2017	

NE66TE

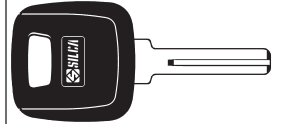

For/Per/Für/Pour/Para:		
VOLVO	→	→
S60	2000	2009
S80	1998	2006
V70	2000	2007
XC70	2001	2007
XC90	2003	2014

NE72ATE

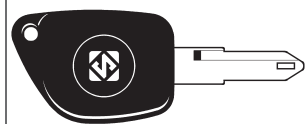

For/Per/Für/Pour/Para:		
NISSAN	→	→
INTERSTAR	2002	2010
OPEL-VAUXHALL	→	→
MOVANO	2002	2010
VIVARO	2002	

PEUGEOT

106	1997	2000
106	2000	2004
206	1998	2001
206	2001	2009
206 CABRIO	2001	2002
206 CABRIO	2002	2007
206 PLUS	2009	2012
306 [SB]	1997	2002
306 [SC]	1997	2002

RENAULT

CLIO II	2001	2012
MASTER	2002	2010
THALIA	2001	2008
TRAFIC	2002	

RENAULT-DACIA

SYMBOL	2010	2013
--------	------	------

NE73TE

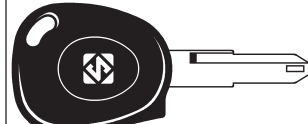

For/Per/Für/Pour/Para:		
DAF	→	→
CF	2002	2012
LF	2002	2012
XF	2002	2012
NISSAN	→	→
INTERSTAR	1998	2001
INTERSTAR	2002	2010
PRIMASTAR	2003	
OPEL-VAUXHALL	→	→
COMBO	1998	2002
MOVANO	1998	2001
MOVANO	2002	2010
VIVARO	2002	

PEUGEOT

106	2000	2004
206	2001	2009
206 CABRIO	2002	2007
206 PLUS	2009	2012

NE73TE

RENAULT	→	→
AVANTIME	2001	2003
CLIO	1995	2001
ESPACE III	1997	2002
LAGUNA	1995	2000
MASTER	1998	2001
MASTER	2002	2010
MEGANE	1996	1998
MEGANE	1998	2000
MEGANE	2000	2003
SAFRANE	1995	2001
TRAFIC	2002	

NE75TE



For/Per/Für/Pour/Para:		
LAND ROVER	→	→
FREELANDER	2003	2006

NE78TE



For/Per/Für/Pour/Para:		
PEUGEOT	→	→
406	1999	2002
406	2002	2004
406 [SB]	1997	1999
406 [SC]	1997	1999
406 [SV]	1997	1999
607	2001	2004
607	2004	2010

NSN11TE

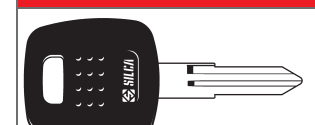

For/Per/Für/Pour/Para:		
FORD EU	→	→
MAVERICK	1995	1997
INFINITI	→	→
I30	1999	2000
LDV	→	→
CUB	1996	2001
NISSAN	→	→

ATLEON	2002	
CAB STAR	2000	2003
CAB STAR	2003	2007
MAXIMA	1995	1999
MAXIMA	2000	2003
MICRA	1996	1998
MICRA	1998	2000
MICRA	2000	2003
MICRA MARCH [J]	1996	1998
MICRA MARCH [J]	1998	2000
MICRA MARCH [J]	2000	2003
MICRA VAN	1998	2000
MICRA VAN	2000	2003
NX ALMERA	1995	1998
NX ALMERA	1998	2000
PRIMERA	1995	1996
PULSAR	1995	1996
SERENA	1996	1999
SUNNY [J]	1996	1998
TERRANO II	1995	1998
TERRANO II	1998	2001
TERRANO II	2002	2006
VANETTE	2000	
VANETTE CARGO	1996	1999
VANETTE CARGO	1999	2000
VANETTE CARGO	2000	

NISSAN USA

MAXIMA	1995	2000
--------	------	------

SUBARU

IMPREZA	1996	2000
LEGACY	1996	1998
OUTBACK	1996	1998



Look A-like Keys with GTI Transponder

Edition
NOVEMBER
2017

TOY43TE

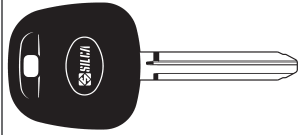

For/Per/Für/Pour/Para:

TOYOTA	→	→
AVENSIS	2003	2011
CARINA	1996	2000
CELICA	1996	2000
COROLLA	1996	1999
COROLLA	1996	2006
COROLLA VERSO	2001	2004
RAV 4	1996	2002
RAV 4	1996	2004
URBAN CRUISER	2009	2014

TOY46RTE

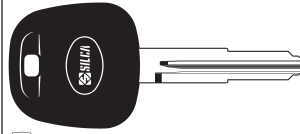

For/Per/Für/Pour/Para:

TOYOTA	→	→
COROLLA	1996	1999

TOY47TE

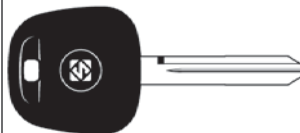

For/Per/Für/Pour/Para:

DAIHATSU	→	→
CHARADE	2011	

TOYOTA	→	→
AURIS (EU)	2007	2012
AURIS (EU)	2009	2012
AVENSIS	1998	2000
AVENSIS	2000	2003
AVENSIS	2003	2011
AVENSIS	2010	2012
CARINA	1996	2000
COROLLA	1999	2006
COROLLA	2004	2009
COROLLA (S.AFRICA)	2008	
YARIS	1999	2005
YARIS	2005	2011
YARIS	2011	2014

TOY48BTE

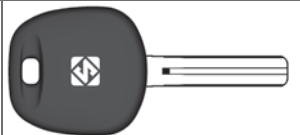

For/Per/Für/Pour/Para:

LEXUS	→	→
ALTEZZA [J]	1999	2005
ES300	2002	2003
ES330	2004	2006
GS/LS/LX	1998	2005
GS300	1998	2001
GS300	1998	2005
GS300	2002	2005
GS300	2006	2008
GS300/400 [J]	1998	2005
GS400	1998	2001
GS430	2001	2005
GS430	2005	2007
GX470	2003	2009
IS200	1999	2005
IS300	2001	2005
IS300	2001	2001
IS300	2002	2005
LS200	1999	2005
LS400	1998	2000
LS430	2001	2006
LX470	2001	2002
LX470	2003	2008
RX300	1997	2003
RX330	2004	2009
RX350	2004	2011
RX400h	2004	2009
RX450h	2010	2010
SC430	2002	2010

TOY48BTE

TOYOTA	→	→
LAND CRUISER 100	2000	2002
LAND CRUISER 100 (AUS)	2002	2005

TOYOTA JAPAN	→	→
ARISTO	1998	2005
BREVIS	2001	2007
CELSIOR	1998	2004
CROWN	1999	2005
LAND CRUISER PRADO	2000	2002
ORIGIN	2000	
PROGRES NC300	1998	2006
WINDOM	2001	2004

TOY49TE



For/Per/Für/Pour/Para:

HYUNDAI	→	→
ACCENT	2012	
AVANTE	2007	2011
ELANTRA Touring (CANADA)	2009	2012
ELANTRA Touring (USA)	1999	2012
GENESIS	2009	2010
I20	2008	2014
I30	2007	2011
I30	2012	
I40	2011	
I40 (AUS)	2010	
I45	2009	
IX20	2010	2012
IX20	2012	
IX35	2010	2015
LANTRA	2007	2011
SB11	2011	
SOLARIS	2011	
TUCSON	2010	2015
TUCSON	2015	
TUCSON (CANADA)	2013	2015
VERNA	2011	

KIA	→	→
BORREGO	2009	2011
CARENS	2013	
CEED	2012	
MAGENTIS	2009	2011
OPIRUS	2007	2010
OPTIMA	2010	2014
RIO	2009	2011
RIO	2012	
RIO (CANADA)	2010	2011
RIO (CANADA)	2012	
RONDO	2013	
SORENTO	2015	
SOUL	2014	
SPORTAGE	2010	2014
SPORTAGE	2014	

TOY51TE



For/Per/Für/Pour/Para:

TOYOTA	→	→
AVENSIS	2012	2015
VERSO	2012	2015

VA2TE



For/Per/Für/Pour/Para:

CITROËN	→	→
BERLINGO	2002	
C1	2004	2014
C2	2003	2010
C3	2002	2016
C3 PICASSO	2008	
C4	2005	2010
C5	2004	2008
C6	2005	2012
DS3	2010	
DS4	2011	

NISSAN	→	→
NV400	2011	

OPEL-VAUXHALL	→	→
MOVANO	2011	

VA2TE

PEUGEOT	→	→
107	2005	2014
407	2004	2011
508	2011	
1007	2004	2010
PARTNER	2002	
RANCH	2002	

RENAULT	→	→
CLIO III	2006	
CLIO IV	2012	
KANGOO	2010	
MASTER	2011	
MODUS	2004	
TWINGO	2007	2014

SMART

SMART	→	→
FORTWO	2007	2014

TOYOTA

TOYOTA	→	→
AYGO	2005	2014

VAC102TE

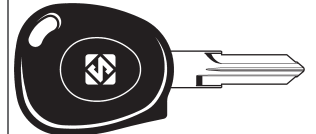

For/Per/Für/Pour/Para:

RENAULT	→	→
CLIO	1995	2001
KANGOO	1998	2001
KANGOO	2002	2010
LAGUNA	1995	2000
SAFRANE	1995	2001
TWINGO	1995	2001
TWINGO	2002	2007

RENAULT-DACIA

RENAULT-DACIA	→	→
DUSTER	2010	2013
LOGAN	2006	2012
SANDERO	2008	2013

WT9TE

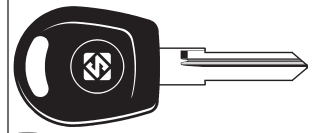

For/Per/Für/Pour/Para:

VOLKSWAGEN S.AMERICA	→	→
SANTANA 2000	1998	2006

YH35RATE

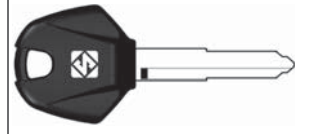

For/Per/Für/Pour/Para:

YAMAHA	→	→
BT1100 BULLDOG	2005	
FJR1300	2005	
FJ-09	2015	
FZ-07	2013	
FZ-09	2013	
FZ1	2006	
FZ6	2004	2011
FZ8	2010	
FZS1000 FAZER	2005	
MAJESTY 400	2005	
MT-01	2005	2012
MT-03	2006	2013
MT-07	2013	
MT-09	2013	
MT-09 TRACER	2015	
TDM600	2005	
T-MAX 500	2005	2014
XJR 1300	2004	
XTR	2004	
XTX	2004	
XT 660Z TÉNÉRÉ	2008	
XT 1200Z SUPER TÉNÉRÉ	2010	
XVS 650A DRAGSTAR	2004	2006
XVS 1100A DRAGSTAR	2004	
YZF-R1	2005	
YZF-R6	2003	

ZD24RTE

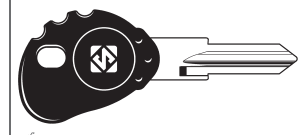

For/Per/Für/Pour/Para:

GILERA	→	→
NEXUS 250	2006	2008
NEXUS 300	2007	

HONDA	→	→
SH 300	2007	

MBK	→	→
BOOSTER	1999	2004

TRIUMPH	→	→
TIGER	2010	

YAMAHA	→	→
AEROX	1998	
NEOS	1998	
X-MAX 125	2006	

→ In production from year... / Fabricata dall'anno...
/ Hergestellt seit Jahr... / Fabriquée à partir de l'année... /
Fabricada desde el año... / Em produção do ano...

→ In production until year... / Fabricata fino
all'anno... / Hergestellt bis Jahr... / Fabriquée jusqu'à
l'année... / Fabricada hasta el año... / Em produção até
o ano...



Look A-like Keys with GTI Transponder

Edition
NOVEMBER
2017

IMPORTANT

In compliance with current regulations relating to industrial property, we hereby state that the trade-marks or trade names mentioned in our catalogue are the exclusive property of authorized manufacturers of locks and users. Said trade-marks or trade names are nominated only for the purposes of information so that any lock for which our keys are made can be rapidly identified. This catalogue is reserved exclusively for professional key cutters who use Silca products.

All information and illustrations in this catalogue are for guidance only. Silca reserves the right to alter products designs, dimensions or info to improve the products quality. The contents of this catalogue are fully protected by Copyright and may not be copied or reproduced in any form, without written permission from Silca. Any infringements will be dealt with under Italian law.

IMPORTANT

Conformément aux lois en vigueur concernant la propriété industrielle, nous vous informons que les marques et appellations commerciales citées dans notre catalogue appartiennent exclusivement aux fabricants de serrures et aux utilisateurs autorisés. Ces marques ou appellations commerciales sont indiquées à titre d'information pure et simple pour vous permettre de déterminer rapidement les serrures auxquelles nos clés sont destinées. Ce catalogue est réservé exclusivement aux professionnels du taillage de clés qui utilisent les produits Silca. Les illustrations et les caractéristiques techniques des produits présentés dans ce catalogue sont données à titre indicatif. Bien que les caractéristiques essentielles des produits soient invariables, Silca se réserve le droit d'apporter toutes les modifications qu'elle retiendra nécessaires et opportunes afin d'améliorer la qualité de ses produits. Tous les dessins et photos sont propriété Silca et toute reproduction, même partielle, sans l'autorisation écrite préalable de Silca est interdite conformément aux prescriptions légales. Tout litige est du ressort exclusif des Tribunaux de la circonscription où se trouve le Siège de la Société.

IMPORTANTE

In conformità alle disposizioni legali in vigore relative alle proprietà industriali, informiamo che i marchi o le denominazioni commerciali citate nel nostro catalogo sono di proprietà esclusiva dei fabbricanti di serrature e degli utilizzatori autorizzati. Questi marchi o denominazioni commerciali sono indicati a titolo di semplice informazione, con lo scopo di riconoscere velocemente a quali serrature le nostre chiavi sono destinate. Questo catalogo è esclusivamente riservato ai professionisti della riproduzione chiavi che utilizzano i prodotti Silca. Le illustrazioni e i dati tecnici dei prodotti contenuti nel catalogo debbono considerarsi indicativi. Silca si riserva il diritto, ferme restando le caratteristiche essenziali dei prodotti, di apportare tutte le modifiche che ritiene necessarie e opportune al fine di migliorare la qualità dei prodotti. Tutti i disegni e le fotografie sono di proprietà di Silca, ogni riproduzione anche parziale, senza autorizzazione scritta della Silca è vietata secondo termini di legge. Per qualsiasi controversia competenti sono gli Uffici Giudiziari dove ha sede l'Azienda, con espressa esclusione di qualsiasi altro foro.

IMPORTANTE

En conformidad con las vigentes disposiciones de ley sobre propiedad industrial, las marcas y denominaciones comerciales citadas en nuestra documentación se declaran de propiedad exclusiva de los fabricantes de cerraduras y los utilizadores autorizados. Dichas marcas o denominaciones comerciales se citan por simple información, al objeto de hacer comprender sin dificultad a qué cerraduras van destinadas nuestras llaves. Esta documentación está reservada exclusivamente a los profesionales de la reproducción de llaves que utilizan los productos Silca. Las ilustraciones y los datos técnicos de los productos en esta documentación son indicativos. La Silca se reserva el derecho, quedando invariables las características principales de los productos, de modificar todo lo que considere necesario y oportuno para mejorar la calidad de sus artículos. Todos los dibujos y las fotografías pertenecen a la Silca; según determina la Ley, se prohíbe toda reproducción aunque parcial, sin autorización por escrito de la Silca S.p.A. En caso de disputas la competencia es de las autoridades judiciales donde está domiciliada la firma, excluyendo cualquier otro fuero.

WICHTIG

Gemäß den derzeit geltenden Normen bezüglich des Industrieigentums teilen wir Ihnen mit, daß die im vorliegenden Katalog angeführten Markennamen oder Handelsmarken ausschließliches Eigentum der Schloßhersteller und zugelassenen Fachhändler sind. Diese Markenbezeichnungen oder Handelsmarken sind nur zur Information angeführt, mit dem Zweck, schnell erkennen zu können, zu welchem Schloß unsere Schlüssel gehören. Der vorliegende Katalog ist ausschließlich an Schlüsselkopier-Fachgeschäfte, die Silca Produkte benützen, gerichtet. Die Abbildungen und technischen Daten des Katalogs sind nur zur Information. Silca behält sich vor, etwaige Änderungen am Produkt, die zur Verbesserung desselben beitragen vorzunehmen. Alle Zeichnungen und Fotos sind Besitz der Firma Silca, jede Reproduktion, auch teilweise, ist ohne schriftliche Erlaubnis der Firma Silca gesetzlich untersagt. Im Falle von Streitfragen ist der Gerichtshof des Firmensitzes zuständig; jeder andere Gerichtshof ist ausgeschlossen.

IMPORTANTE

Em conformidade com as disposições legais em vigor relativas à propriedade industrial, informamos que as marcas ou as denominações comerciais citadas no nosso catálogo são propriedade exclusiva dos fabricantes de fechaduras e dos utilizadores autorizados. Estas marcas ou denominações comerciais são indicadas só a nível de informação, a fim de reconhecer rapidamente a quais fechaduras se destinam as nossas chaves. Este catálogo é reservado exclusivamente aos profissionais da reprodução de chaves que utilizam os produtos Silca. As ilustrações e as características técnicas dos produtos apresentados neste catálogo são facultados a título indicativo. Mesmo que as características essenciais dos produtos sejam invariáveis, à Silca reserva-se o direito de modificar ser necessário e oportuno os produtos, afim de melhorar a sua qualidade. Todos os desenhos e fotos são propriedade da Silca, e é proibida a sua reprodução mesmo parcial sem a autorização escrita da Silca conforme as prescrições legais. Em caso de litígio fica desde já designado, excluindo qualquer outro Tribunal da comarca onde está registrada a sede da Silca.