



3

Milling Slot Cutters

IT	Frese a Seghetto
DE	Schlitzfräser
FR	Fraises Scie
ES	Fresas Dentadas
PT	Fresas com Dentes

P. 47	Special Cutters
	Frese Speciali
	Spezialfräser
	Fraises Spéciales
	Fresas Especiales
	Fresas Especiais

Milling Slot Cutters

Frese a Seghetto / Schlitzfräser / Fraises Scie / Fresas Dentadas / Fresas com Dentes

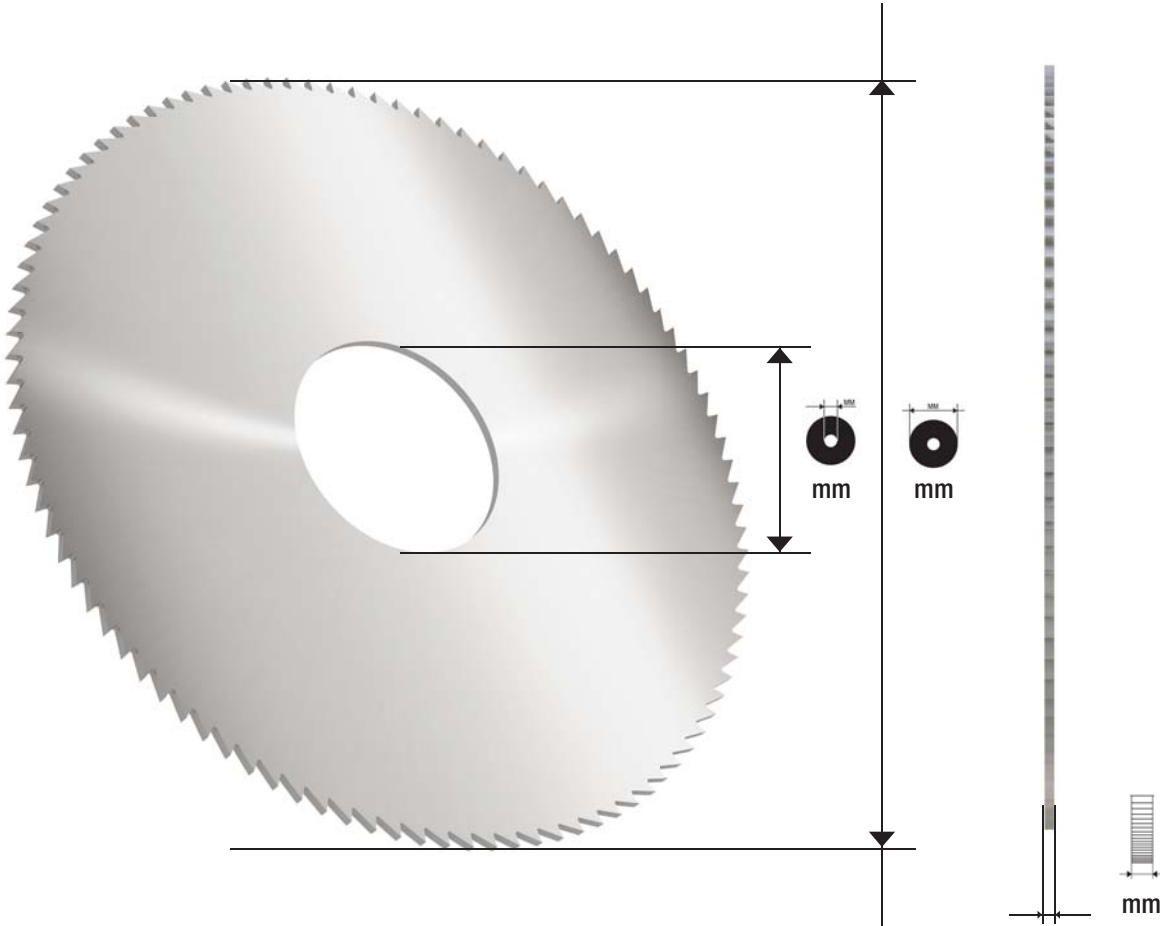

Symbols / Segni convenzionali / Unterscheidungszeichen / Signes conventionnels / Señales convencionales / Sinais convencionais



Carbide cutter
Fresa in metallo duro
Hartmetall Fräser
Fraise au carbure
Fresa en acero duro
Fresa em aço duro

HSS

High Speed Steel
Acciaio Super Rapido
Hochleistung-Schnellstahl
Acier Super Rapide
Acero Super Rápido
Aço Super Rápido



External diameter
Diámetro externo
Aussen-Durchmesser
Diamètre extérieur
Diámetro exterior
Diámetro externo



Internal diameter
Diámetro interno
Innen-Durchmesser
Alésage
Diámetro interior
Diámetro interno

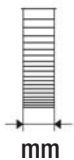

Cutter thickness
Spessore
Stärke
Épaisseur
Espesor
Espessura

















Milling cutter with side cuts
Fresa a tagli laterali
Fräser mit Seiteneinschnitten
Fraise à découpes latérales
Fresa con cortes laterales
Fresa a cortes laterais



Thread size
Filettatura
Gewindeschneiden
Dimension taraudage
Roscado
Tamanho da espiral















Milling Slot Cutters

Frese a Seghetto / Schlitzfräser / Fraises Scie / Fresas Dentadas / Fresas com Dentes

Model Modello Modell Modél Modelo	Code Codice Kode Code Código Código	 HSS	 (mm)	 (mm)	 (mm)			No. of teeth Numero denti Zähne Nombre de dents Número de dientes Número de dentes	Key Cutting Machines Duplicatrici Schlüsselkopiermaschinen Machines à tailler les clés Duplicadoras Duplicadoras
SG14	D712505ZB	HSS	60,4	9,52	1,14			70	DELTA 2000 DELTA 2000 FO DELTA 2000 AY DELTA 2000 BRAZIL
SG15	D712506ZB	HSS	60,4	9,52	0,76			70	DELTA 2000 JAPAN DELTA 2000 FS DELTA 2000 SOFER DELTA PLUS
SG15W	D717968ZB		60,4	9,52	0,76			70	
SG18	D913645ZR	HSS	64,6	9,52	2,4	X		40	
SG19	D714448ZB	HSS	64,6	9,52	1,5	X		70	DELTA 2000 DELTA 2000 FO DELTA 2000 AY DELTA 2000 BRAZIL DELTA 2000 JAPAN DELTA 2000 FS DELTA 2000 SOFER DELTA PLUS DELTA 2000 MC
PL1.00	D710036ZB		100	22	1			100	IDEA PRIMA LASER
PL1.25	D736154ZB		100	22	1,25			100	
PL1.50	D709696ZB		100	22	1,5			100	
PL1.70	D723584ZB		100	22	1,7			100	
PL1.90	D712527ZB		100	22	1,9			100	
PL2.20	D723422ZB		100	22	2,2			100	
PL2.40	D714465ZB		100	22	2,4			100	
SG5	D705374ZB	HSS	80	22	1,3			100	LANCER PLUS
SG6	D700204ZB	HSS	80	22	1,3	X		100	
SG10	D700081ZB	HSS	80	22	2			100	
SG1	D700080ZB	HSS	80	22	1,5			100	OPERA III OPERA IV TARGA 2000 TECH3 TECHNICA
SG1W	D704784ZB		80	22	1,5			100	
SG3	D700078ZB	HSS	80	22	1			100	











Milling Slot Cutters

Frese a Seghetto / Schlitzfräser / Fraises Scie / Fresas Dentadas / Fresas com Dentes

Model Modello Modell Modél Modelo Modelo	Code Codice Kode Code Código Código	 HSS	 (mm)	 (mm)	 (mm)			No. of teeth Numero denti Zähne Nombre de dents Número de dientes Número de dentes	Key Cutting Machines Duplicatrici Schlüsselkopiermaschinen Machines à tailler les clés Duplicadoras Duplicadoras
SG4	D700079ZB	HSS	80	22	1,25			100	OPERA III OPERA IV TARGA 2000 TECH3 TECHNICA TECHNICA UK
SG7	D703222ZB	HSS	80	22	1,4			100	OPERA III OPERA IV TARGA 2000 TECH3 TECHNICA
SG8	D702863ZB	HSS	80	22	1,75			100	TECH3 TECHNICA
SG23 FLAT	D734963ZB	HSS	80	22	1,25			100	DUO / DUO PLUS / DUO POWER DUO SA / DUO SOFER / OPERA IV TARGA 2000 / TECH3 / TECHNICA OPERA III
SG3W	D711025ZB		80	22	1			100	OPERA III / OPERA IV / TECH3 TECHNICA
PL1.6	D730435ZB		100	22	1,6			100	PRIMA LASER
PL1.65	D737787ZB		100	22	1,65			100	
PL1.8	D735331ZB		100	22	1,8			100	
PL1.25	D726023ZB		100	22	1,25			100	IDEA / PRIMA LASER
PL2.5	D738936ZB		100	22	2,5			100	PRIMA LASER
PL2.00	D723621ZB		100	22	2			100	
-	D701677ZB	TITANIUM	80	22	1,5			100	TARGA 2000 TECH3 TECHNICA
SG2	D701744ZB	HSS	80	22	1,5	X		100	
SG13	D712450ZB	HSS	64,6	9,52	2			70	UNOCODE / UNOCODE 299 UNOCODE 399 / UNOCODE 399 EVO / DELTA PLUS DELTA 2000 FO / DELTA 2000 AY DELTA AB60P
05	D702837ZB	HSS	60,4	9,52	1,8			66	UNOCODE UNOCODE 299 UNOCODE 399 UNOCODE 399 EVO
06	D705040ZB	HSS	64,6	9,52	2,4			70	ULTRACODE
05W	D705633ZB		60,4	9,52	1,8			68	

Milling Slot Cutters

Frese a Seghetto / Schlitzfräser / Fraises Scie / Fresas Dentadas / Fresas com Dentes

Model Modello Modell Modél Modelo	Code Codice Code Código Código	 HSS	 (mm)	 (mm)	 (mm)			No. of teeth Numero denti Zähne Nombre de dents Número de dientes Número de dentes	Key Cutting Machines Duplicatrici Schlüsselkopiermaschinen Machines à tailler les clés Duplicadoras Duplicadoras	
06W	D706128ZB		64,6	9,52	2,4			70	UNOCODE UNOCODE 299 UNOCODE 399 UNOCODE 399 EVO ULTRACODE	
GB1	D705690ZB	HSS	60,4	9,52	1,7			66		
SG13W	D723158ZB		64,6	9,52	2			70	UNOCODE 299 UNOCODE 399	
SG27W	D736505ZB		64,6	9,52	1,4			70	UNOCODE 299 / UNOCODE 399 UNOCODE 399 EVO UNOCODE 399 PLUS	
-	D726511ZB		63	16	1,25			80	OLYMPC	
-	D926289ZR		63	16	1,5			80		
Special Cutters Frese Speciali / Spezialfräser / Fraises Spéciales / Fresas Especiales / Fresas Especiais										
-	D703144ZB	HSS	25	0	1,25			8	40	LANCER PLUS
-	D711119ZB	HSS	25	5,2	1,25	X		40		
-	D740601ZB	HSS	25	0	1,25			8	40	

Trade Marks

Marchi Registrati / Registrierte Handelsmarken / Marques Déposées / Marcas Registradas / Marcas Registradas

ENGLISH

In compliance with current regulations relating to industrial property, we hereby state that the trade-marks or trade names mentioned in this document are the exclusive property of authorized manufacturers of locks and users. Said trade-marks or trade names are nominated only for the purposes of information so that any lock for which our keys are made can be rapidly identified. This document is reserved exclusively for professional key cutters who use Silca products. All information and illustrations in this document are for guidance only. Silca reserves the right to alter products designs, dimensions or info to improve the products quality. The contents of this document are fully protected by Copyright and may not be copied or reproduced in any form, without written permission from Silca S.p.A. Any controversy shall be settled by the Courts of Justice where the company has its headquarters, with express exclusion of any other court.

ITALIANO

In conformità alle disposizioni legali in vigore relative alle proprietà industriali, informiamo che i marchi o le denominazioni commerciali citate nel nostro documento sono di proprietà esclusiva dei Fabbricanti di Serrature e degli utilizzatori autorizzati. Questi marchi o denominazioni commerciali sono indicati a titolo di semplice informazione, con lo scopo di riconoscere velocemente a quali serrature le nostre chiavi sono destinate. Questo documento è esclusivamente riservato ai professionisti della riproduzione chiavi che utilizzano i prodotti Silca. Le illustrazioni e i dati tecnici dei prodotti contenuti nel documento debbono considerarsi indicativi. Silca si riserva il diritto, ferme restando le caratteristiche essenziali dei prodotti, di apportare tutte le modifiche che ritiene necessarie e opportune al fine di migliorare la qualità dei prodotti. Tutti i disegni e le fotografie sono di proprietà di Silca, ogni riproduzione anche parziale, senza autorizzazione scritta di Silca S.p.A. è vietata secondo termini di legge. Per qualsiasi controversia competenti sono gli Uffici Giudiziari dove ha sede l'Azienda, con espressa esclusione di qualsiasi altro foro.

DEUTSCH

Gemäß den derzeit geltenden Normen bezüglich des Industrieigentums teilen wir Ihnen mit, dass die in der vorliegenden Broschüre angeführten Markennamen oder Handelsmarken ausschließliches Eigentum der Schlosshersteller und zugelassenen Fachhändler sind. Diese Markenbezeichnungen oder Handelsmarken sind nur zur Information angeführt, mit dem Zweck, schnell erkennen zu können, zu welchem Schloss unsere Schlüssel gehören. Die vorliegende Broschüre ist ausschließlich an Fachgeschäfte gerichtet, die Silca Produkte einsetzen. / Die Abbildungen und technischen Daten in dieser Broschüre sind nur zur Information. Silca behält sich vor, etwaige Änderungen, die zur Verbesserung des Produktes beitragen, vorzunehmen. Alle Zeichnungen und Fotos sind Eigentum der Firma Silca. Jede Reproduktion, auch teilweise, ist ohne ausdrückliche Genehmigung der Silca S.p.A. gesetzlich untersagt. Im Falle von Streitfragen ist der Gerichtsstand des Firmensitzes zuständig; jeder andere Gerichtsstand ist ausgeschlossen.

FRANÇAIS

Conformément aux lois en vigueur concernant la propriété industrielle, nous vous informons que les marques et appellations commerciales citées dans notre documentation appartiennent exclusivement aux fabricants de serrures et aux utilisateurs autorisés. Ces marques ou appellations commerciales sont indiquées à titre d'information pure et simple pour vous permettre de déterminer rapidement les serrures auxquelles nos clés sont destinées. Cette documentation est réservée exclusivement aux professionnels du taillage de clés qui utilisent les produits Silca. Les illustrations et les caractéristiques techniques des produits présentés dans cette documentation sont données à titre indicatif. Bien que les caractéristiques essentielles des produits soient invariables, Silca se réserve le droit d'apporter toutes les modifications qu'elle retiendra nécessaires et opportunes afin d'améliorer la qualité de ses produits. Tous les dessins et photos sont propriété Silca et toute reproduction, même partielle, sans l'autorisation écrite préalable de Silca S.p.A. est interdite conformément aux prescriptions légales. Tout litige est du ressort exclusif des Tribunaux de la circonscription où se trouve le Siège de la Société.

ESPAÑOL

En conformidad con las disposiciones legales vigentes sobre la Propiedad Industrial, las marcas y denominaciones comerciales citadas en nuestra documentación se declaran propiedad exclusiva de los fabricantes de cerraduras y los usuarios autorizados. Dichas marcas o denominaciones comerciales se citan con mero carácter informativo, con objeto de hacer comprender sin dificultad a qué cerraduras van destinadas nuestras llaves. Esta documentación está reservada exclusivamente a los profesionales de la duplicación de llaves que utilizan los productos Silca. / Las ilustraciones y los datos técnicos de los productos en esta documentación son indicativos. Silca se reserva el derecho, quedando invariables las características principales de los productos, de modificar todo lo que considere necesario y oportuno para mejorar la calidad de sus artículos. Todos los dibujos y fotografías pertenecen a Silca; según determina la Ley, se prohíbe toda reproducción, total o parcial, sin autorización por escrito de Silca S.p.A. En caso de disconformidad, la competencia es de las autoridades judiciales donde esté domiciliada la firma, excluyendo cualquier otro Tribunal.

PORTUGÜES

Em conformidade com as disposições legais em vigor relativas à propriedade industrial, informamos que as marcas ou as denominações comerciais citadas na nossa documentação são propriedade exclusiva dos fabricantes de fechaduras e dos utilizadores autorizados. Estas marcas ou denominações comerciais são indicadas só a nível de informação, a fim de reconhecer rapidamente a quais fechaduras se destinam as nossas chaves. Esta documentação é reservada exclusivamente aos profissionais da reprodução de chaves que utilizam os produtos Silca. / As ilustrações e as características técnicas dos produtos apresentados nesta documentação são facultados a título indicativo. Mesmo que as características essenciais dos produtos sejam invariáveis, à Silca reserva-se o direito de modificar ser necessário e oportuno los productos, afim de melhorar a sua qualidade. Todos os desenhos e fotos são propriedade da Silca, e é proibida a sua reprodução mesmo parcial sem a autorização escrita da Silca S.p.A. conforme as prescrições legais. Em caso de litígio fica desde já designado, excluindo qualquer outro, o Tribunal da comarca onde está registada a sede da Silca.