



2

Double Angle Cutters

- IT Frese Prismatiche
- DE Prismen Fräser
- FR Fraises Isocèles
- ES Fresas Isósceles
- PT Fresas Isósceles

Double Angle Cutters

Frese Prismatiche / Prismen Fräser / Fraises Isocèles / Fresas Isósceles / Fresas Isòsceles

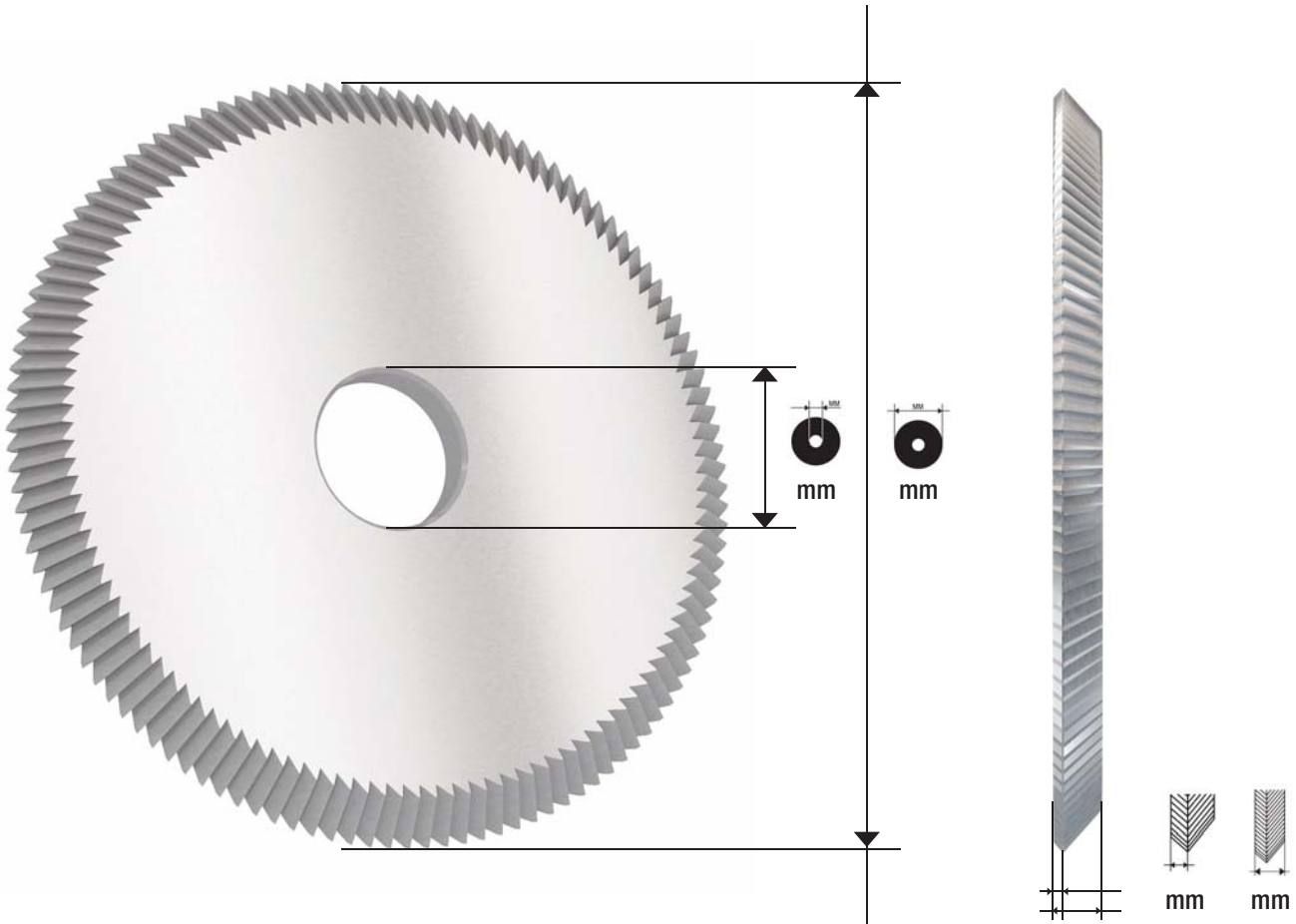

Symbols / Segni convenzionali / Unterscheidungszeichen / Signes conventionnels / Señales convencionales / Símbolos convencionais



Carbide cutter
Fresa in metallo duro
Hartmetall Fräser
Fraise au carbure
Fresa en acero duro
Fresa em aço duro

HSS

High Speed Steel
Acciaio Super Rapido
Hochleistung-Schnellstahl
Acier Super Rapide
Acero Super Rápido
Aço Super Rápido



mm

External diameter
Diametro esterno
Aussen-Durchmesser
Diamètre extérieur
Diámetro exterior
Diâmetro externo



mm

Internal diameter
Diametro interno
Innen-Durchmesser
Alésage
Diámetro interior
Diâmetro interno



mm

Cutter thickness
Spessore
Stärke
Épaisseur
Espesor
Espessura



Cutting angle
Angolo di taglio
Einschnittwinkel
Angle de coupe
Ángulo de corte
Ângulo de corte



mm

Cutter tip width
Piano di cifratura
Flach-Einschnitt
Partie plate angle de coupe
Parte llana ángulo de corte
Largura da ponta da fresa









mm

Distance from the center to the side
Distanza dal centro al lato
Abstand vom Mittelpunkt des Fräasers zur Seite
Distance entre le centre de la fraise et son bord
Distancia desde el centro hacia el lado
Distância do centro à lateral











Double Angle Cutters

Frese Prismatiche / Prismen Fräser / Fraises Isocèles / Fresas Isósceles / Fresas Isósceles

Model Modello Modell Modél Modelo Modelo	Code Codice Code Code Código Código	 HSS	 (mm)	 (mm)	 (mm)	 α°	 (mm)	No. of teeth Numero denti Zähne Nombre de dents Número de dientes Número de dentes	 (mm)	Key Cutting Machines Duplicatrici Schlüsselkopiermaschinen Machines à tailler les clés Duplicadoras Duplicadoras
02	D702845ZB	HSS	60,4	9,52	7,6	100	1	80	2,8	UNOCODE UNOCODE 299 UNOCODE 399 UNOCODE 399 EVO ULTRACODE
03	D702846ZB	HSS	60,4	9,52	6,9	100	1	80	2,1	UNOCODE UNOCODE 299 UNOCODE 399 UNOCODE 399 EVO ULTRACODE
04	D702847ZB	HSS	60,4	9,52	7,2	85	1	72	2,4	UNOCODE UNOCODE 299 UNOCODE 399 UNOCODE 399 EVO ULTRACODE
07	D705689ZB	HSS	60,4	9,52	7,2	90	0,6	80	2,4	UNOCODE UNOCODE 299 UNOCODE 399 UNOCODE 399 EVO ULTRACODE
A1S	D706157ZB	HSS	80	16	9,5	110	0	110	4,75	BRAVO EVOLUTION BRAVO MAXIMA / BRAVO SOFER
A2	D702221ZB	HSS	60,4	9,52	8,95	90	0,8	80	4,2	UNOCODE / UNOCODE 299 UNOCODE 399 UNOCODE 399 EVO ULTRACODE
A2S	D706158ZB	HSS	80	16	8,95	90	0,8	110	4,2	BRAVO EVOLUTION BRAVO MAXIMA / BRAVO SOFER
A3	D702222ZB	HSS	60,4	9,52	9,5	90	1,5	80	4,75	UNOCODE / UNOCODE 299 UNOCODE 399 UNOCODE 399 EVO ULTRACODE
A3S	D706159ZB	HSS	80	16	9,5	90	1,5	110	4,75	BRAVO EVOLUTION BRAVO MAXIMA / BRAVO SOFER
A4	D705691ZB	HSS	60,4	9,52	8,9	110	0,55	80	4,15	UNOCODE UNOCODE 299 UNOCODE 399 UNOCODE 399 EVO ULTRACODE
CW1011	D702855ZB	HSS	60,4	9,52	7,35	90	1,2	80	2,6	UNOCODE UNOCODE 299 UNOCODE 399 UNOCODE 399 EVO ULTRACODE
CW1012	D702851ZB	HSS	60,4	9,52	9,5	85	0,32	80	4,75	UNOCODE UNOCODE 299 UNOCODE 399 UNOCODE 399 EVO ULTRACODE
CW1014MC	D702853ZB	HSS	60,4	9,52	9,5	100	1,3	80	4,75	UNOCODE UNOCODE 299 UNOCODE 399 UNOCODE 399 EVO ULTRACODE
CW20FM	D702854ZB	HSS	60,4	9,52	9,5	76	1,6	80	4,75	UNOCODE UNOCODE 299 UNOCODE 399 UNOCODE 399 EVO ULTRACODE
D1	D705634ZB	HSS	60,4	9,52	7,6	100	0,8	80	2,8	UNOCODE UNOCODE 299 UNOCODE 399 UNOCODE 399 EVO ULTRACODE
DK2	D702849ZB	HSS	60,4	8,55	8,55	105	0,7	80	3,75	UNOCODE UNOCODE 299 UNOCODE 399 UNOCODE 399 EVO ULTRACODE
P01	D700875ZB	HSS	80	16	5	84	0,15	110	1	BRAVO EVOLUTION BRAVO PROFESSIONAL BRAVO MAXIMA / BRAVO W-MAX BRAVO SOFER BRAVO BD EVOLUTION BRAVO JAPAN BRAVO MAX JAPAN / BRAVO III POKER PLUS / POKER S / REKORD REKORD BRAZIL / REKORD SOFER















Double Angle Cutters

Frese Prismatische / Prismen Fräser / Fraises Isocèles / Fresas Isósceles / Fresas Isòsceles

Model Modello Modell Modél Modelo Modelo	Code Codice Kode Code Código Código	 HSS	 (mm)	 (mm)	 (mm)	 84°	 (mm)	No. of teeth Numero denti Zähne Nombre de dents Número de dientes Número de dentes	 (mm)	Key Cutting Machines Duplicatrici Schlüsselkopiermaschinen Machines à tailler les clés Duplicadoras Duplicadoras
P01W	D704861ZB		80	16	5	84	0,15	80	1	BRAVO EVOLUTION BRAVO PROFESSIONAL BRAVO MAXIMA / BRAVO W-MAX BRAVO SOFER BRAVO BD EVOLUTION BRAVO JAPAN BRAVO MAX.JAPAN / BRAVO III POKER PLUS / POKER S
P03	D701642ZB	HSS	80	16	7	100	0	100	3	REKORD 2000
P12	D709991ZB	HSS	80	15,98	8,5	100	1,5	110	4	BRAVO EVOLUTION BRAVO SOFER
P13	D709993ZB	HSS	80	16	8,5	90	0,6	110	4,5	
P14	D709992ZB	HSS	80	16	7,9	104	0,4	110	3,9	
P15	D710207ZB	HSS	80	16	8,5	90	0,8	110	4,5	
P21	D911868ZR	HSS	60,4	9,52	5,25	84	0,15	70	0,5	DELTA 2000 / DELTA 2000 FO DELTA 2000 AY DELTA 2000 BRAZIL DELTA 2000 JAPAN DELTA 2000 FS DELTA 2000 SOFER / DELTA PLUS
P24	D713055ZB		60,4	9,52	7	100	1,2	70	3,5	UNOCODE UNOCODE 299 UNOCODE 399 UNOCODE 399 EVO ULTRACODE
P26	D713125ZB		64,6	9,52	3,4	113	0,8	70	1,7	
P27	D713126ZB		64,6	9,52	3,8	120	0,8	70	1,9	
P31	D717879ZB	HSS	80	16	7,9	92	0,8	110	3,9	BRAVO EVOLUTION BRAVO BD EVOLUTION BRAVO PROFESSIONAL BRAVO MAXIMA / BRAVO W-MAX BRAVO SOFER / BRAVO JAPAN BRAVO MAX JAPAN
P32	D717898ZB	HSS	80	16	5	80	0	110	0,5	BRAVO EVOLUTION BRAVO PROFESSIONAL BRAVO MAXIMA / BRAVO W-MAX BRAVO SOFER BRAVO BD EVOLUTION BRAVO JAPAN BRAVO MAX JAPAN / BRAVO III
P35	D722462ZB	HSS	80	16	8	82	0,9	110	4	BRAVO EVOLUTION BRAVO BD EVOLUTION BRAVO PROFESSIONAL BRAVO MAXIMA / BRAVO W-MAX BRAVO SOFER / BRAVO JAPAN BRAVO MAX JAPAN

Double Angle Cutters

Frese Prismatiche / Prismen Fräser / Fraises Isocèles / Fresas Isósceles / Fresas Isósceles

Model Modello Modell Modél Modelo	Code Codice Code Código Código	 HSS	 (mm)	 (mm)	 (mm)	 84°	 (mm)	No. of teeth Numero denti Zähne Nombre de dents Número de dientes Número de dientes	 (mm)	Key Cutting Machines Duplicatrici Schlüsselkopiermaschinen Machines à tailler les clés Duplicadoras Duplicadoras
P36	D726407ZB	HSS	80	16	5	84	0,15	110	1	BRAVO EVOLUTION BRAVO PROFESSIONAL BRAVO MAXIMA / BRAVO W-MAX BRAVO SOFER BRAVO BD EVOLUTION BRAVO JAPAN BRAVO MAX JAPAN / BRAVO III
P37	D727882ZB		60,4	9,52	4,8	40	0,1	70	0,05	UNOCODE UNOCODE 299 UNOCODE 399 UNOCODE 399 EVO ULTRACODE
P38	D731196ZB	HSS	80	16	8,5	90	1,3	110	0	BRAVO EVOLUTION BRAVO BD EVOLUTION BRAVO PROFESSIONAL BRAVO MAXIMA / BRAVO W-MAX BRAVO SOFER / BRAVO JAPAN / BRAVO MAX JAPAN
P41	D738583ZB		60,4	9,52	9,5	75	0,75	70	4,75	UNOCODE 399 PLUS
PR	D735282ZB	HSS	80	16	5	84	0,15	100	0	DUO / DUO PLUS / DUO SA DUO POWER / DUO SOFER
S1	D700747ZB	HSS	60,4	9,52	8,8	104	0,4	80	4	UNOCODE UNOCODE 299 UNOCODE 399 UNOCODE 399 EVO ULTRACODE
S3	D706199ZB	HSS	60,4	9,52	9,5	90	1,3	80	4,75	UNOCODE UNOCODE 299 UNOCODE 399 UNOCODE 399 EVO ULTRACODE
U01	D716549ZB	HSS	60,4	9,52	5,25	80	0,1	70	0,5	UNOCODE UNOCODE 299 UNOCODE 399 UNOCODE 399 EVO ULTRACODE LEONARDO
U01W	D734910ZB		60,4	9,52	5,25	80	0,1	70	0,5	UNOCODE / UNOCODE 399 / UNOCODE 399 EVO
U02W	D706249ZB		60,4	9,52	4,75	40	0,15	60	0	UNOCODE UNOCODE 299 UNOCODE 399 UNOCODE 399 EVO ULTRACODE
U05W	D706731ZB		60,4	9,52	5,25	90	0,4	60	0,5	UNOCODE UNOCODE 299 UNOCODE 399 UNOCODE 399 EVO ULTRACODE
U07W	D709224ZB		60,4	9,52	5,25	112	0,1	60	0,5	
U08W	D709225ZB		60,4	9,52	5,25	100	0,4	60	0,5	

Trade Marks

Marchi Registrati / Registrierte Handelsmarken / Marques Déposées / Marcas Registradas / Marcas Registradas

ENGLISH

In compliance with current regulations relating to industrial property, we hereby state that the trade-marks or trade names mentioned in this document are the exclusive property of authorized manufacturers of locks and users. Said trade-marks or trade names are nominated only for the purposes of information so that any lock for which our keys are made can be rapidly identified. This document is reserved exclusively for professional key cutters who use Silca products. All information and illustrations in this document are for guidance only. Silca reserves the right to alter products designs, dimensions or info to improve the products quality. The contents of this document are fully protected by Copyright and may not be copied or reproduced in any form, without written permission from Silca S.p.A. Any controversy shall be settled by the Courts of Justice where the company has its headquarters, with express exclusion of any other court.

ITALIANO

In conformità alle disposizioni legali in vigore relative alle proprietà industriali, informiamo che i marchi o le denominazioni commerciali citate nel nostro documento sono di proprietà esclusiva dei Fabbricanti di Serrature e degli utilizzatori autorizzati. Questi marchi o denominazioni commerciali sono indicati a titolo di semplice informazione, con lo scopo di riconoscere velocemente a quali serrature le nostre chiavi sono destinate. Questo documento è esclusivamente riservato ai professionisti della riproduzione chiavi che utilizzano i prodotti Silca. Le illustrazioni e i dati tecnici dei prodotti contenuti nel documento debbono considerarsi indicativi. Silca si riserva il diritto, ferme restando le caratteristiche essenziali dei prodotti, di apportare tutte le modifiche che ritiene necessarie e opportune al fine di migliorare la qualità dei prodotti. Tutti i disegni e le fotografie sono di proprietà di Silca, ogni riproduzione anche parziale, senza autorizzazione scritta di Silca S.p.A. è vietata secondo termini di legge. Per qualsiasi controversia competenti sono gli Uffici Giudiziari dove ha sede l'Azienda, con espressa esclusione di qualsiasi altro foro.

DEUTSCH

Gemäß den derzeit geltenden Normen bezüglich des Industrieigentums teilen wir Ihnen mit, dass die in der vorliegenden Broschüre angeführten Markennamen oder Handelsmarken ausschließliches Eigentum der Schlosshersteller und zugelassenen Fachhändler sind. Diese Markenbezeichnungen oder Handelsmarken sind nur zur Information angeführt, mit dem Zweck, schnell erkennen zu können, zu welchem Schloss unsere Schlüssel gehören. Die vorliegende Broschüre ist ausschließlich an Fachgeschäfte gerichtet, die Silca Produkte einsetzen. / Die Abbildungen und technischen Daten in dieser Broschüre sind nur zur Information. Silca behält sich vor, etwaige Änderungen, die zur Verbesserung des Produktes beitragen, vorzunehmen. Alle Zeichnungen und Fotos sind Eigentum der Firma Silca. Jede Reproduktion, auch teilweise, ist ohne ausdrückliche Genehmigung der Silca S.p.A. gesetzlich untersagt. Im Falle von Streitfragen ist der Gerichtsstand des Firmensitzes zuständig; jeder andere Gerichtsstand ist ausgeschlossen.

FRANÇAIS

Conformément aux lois en vigueur concernant la propriété industrielle, nous vous informons que les marques et appellations commerciales citées dans notre documentation appartiennent exclusivement aux fabricants de serrures et aux utilisateurs autorisés. Ces marques ou appellations commerciales sont indiquées à titre d'information pure et simple pour vous permettre de déterminer rapidement les serrures auxquelles nos clés sont destinées. Cette documentation est réservée exclusivement aux professionnels du taillage de clés qui utilisent les produits Silca. Les illustrations et les caractéristiques techniques des produits présentés dans cette documentation sont données à titre indicatif. Bien que les caractéristiques essentielles des produits soient invariables, Silca se réserve le droit d'apporter toutes les modifications qu'elle retiendra nécessaires et opportunes afin d'améliorer la qualité de ses produits. Tous les dessins et photos sont propriété Silca et toute reproduction, même partielle, sans l'autorisation écrite préalable de Silca S.p.A. est interdite conformément aux prescriptions légales. Tout litige est du ressort exclusif des Tribunaux de la circonscription où se trouve le Siège de la Société.

ESPAÑOL

En conformidad con las disposiciones legales vigentes sobre la Propiedad Industrial, las marcas y denominaciones comerciales citadas en nuestra documentación se declaran propiedad exclusiva de los fabricantes de cerraduras y los usuarios autorizados. Dichas marcas o denominaciones comerciales se citan con mero carácter informativo, con objeto de hacer comprender sin dificultad a qué cerraduras van destinadas nuestras llaves. Esta documentación está reservada exclusivamente a los profesionales de la duplicación de llaves que utilizan los productos Silca. / Las ilustraciones y los datos técnicos de los productos en esta documentación son indicativos. Silca se reserva el derecho, quedando invariables las características principales de los productos, de modificar todo lo que considere necesario y oportuno para mejorar la calidad de sus artículos. Todos los dibujos y fotografías pertenecen a Silca; según determina la Ley, se prohíbe toda reproducción, total o parcial, sin autorización por escrito de Silca S.p.A. En caso de disconformidad, la competencia es de las autoridades judiciales donde esté domiciliada la firma, excluyendo cualquier otro Tribunal.

PORTUGÜES

Em conformidade com as disposições legais em vigor relativas à propriedade industrial, informamos que as marcas ou as denominações comerciais citadas na nossa documentação são propriedade exclusiva dos fabricantes de fechaduras e dos utilizadores autorizados. Estas marcas ou denominações comerciais são indicadas só a nível de informação, a fim de reconhecer rapidamente a quais fechaduras se destinam as nossas chaves. Esta documentação é reservada exclusivamente aos profissionais da reprodução de chaves que utilizam os produtos Silca. / As ilustrações e as características técnicas dos produtos apresentados nesta documentação são facultados a título indicativo. Mesmo que as características essenciais dos produtos sejam invariáveis, à Silca reserva-se o direito de modificar ser necessário e oportuno los productos, afim de melhorar a sua qualidade. Todos os desenhos e fotos são propriedade da Silca, e é proibida a sua reprodução mesmo parcial sem a autorização escrita da Silca S.p.A. conforme as prescrições legais. Em caso de litígio fica desde já designado, excluindo qualquer outro, o Tribunal da comarca onde está registada a sede da Silca.